



FALCON 15/10

HYDRAULIC ROTARY MOWER

Published 03/09

Part No. 02985378C

OPERATOR'S MANUAL



This Operator's Manual is an integral part of the safe operation of this machine and must be maintained with the unit at all times. READ, UNDERSTAND, and FOLLOW the Safety and Operation Instructions contained in this manual before operating the equipment. *C01-Cover*



ALAMO INDUSTRIAL®

1502 E. Walnut
Seguin, Texas 78155
830-372-3551
Email: parts@alamo-industrial.com

¡ATENCIÓN!

Si No Lee Ingles, Pida Ayuda a Alguien
Que Si Lo Lea Para Que le Traduzca las
Medidas de Seguridad.

LEA EL INSTRUCTIVO



To the Owner/Operator/Dealer





All implements with moving parts are potentially hazardous. There is no substitute for a cautious, safe-minded operator who recognizes the potential hazards and follows reasonable safety practices. The manufacturer has designed this implement to be used with all its safety equipment properly attached to minimize the chance of accidents.

BEFORE YOU START!! Read the safety messages on the implement and shown in your manual. Observe the rules of safety and common sense!



DANGER

FAILING TO FOLLOW SAFETY MESSAGES AND OPERATING INSTRUCTIONS CAN CAUSE SERIOUS BODILY INJURY OR EVEN DEATH TO OPERATOR AND OTHERS IN THE AREA.

<p>1.</p> 	<p>2. NORIDERS. NO CHILDREN OPERATORS.</p> 	<p>3. USE SAFETY SHOES, HARD HAT, SAFETY GLASSES, SEAT BELTS, & ROPS.</p> 	<p>4. BLOCK UP SECURELY BEFORE WORKING UNDER.</p> 
---	--	--	---

1. Study and understand Operator's Manuals, Safety Signs, and Instructional Decals for tractor and implement to prevent misuse, abuse and accidents.

- Learn how to stop engine suddenly in an emergency. Be alert for passersby and especially children.

2. Allow no children on or near implement or tractor. Allow no riders on tractor or implement. Falling off may cause serious injury or death from being run over by tractor or cutter or contact with rotating blades.

3. Operate only with tractor having Roll-Over Protective Structure (ROPS) and with seatbelt fastened securely and snugly to prevent injury and possible death from falling off or tractor overturn. Personal Protective Equipment such as Hard Hat, Safety Glasses, Safety shoes, and Ear Plugs are recommended.

4. Block up or support raised machine and all lifted components securely before putting hands or feet under or working underneath any lifted components to prevent crushing injury or death from sudden dropping or inadvertent operation of controls. Make certain area is clear before lowering or folding.

5. Before transporting, put Lift Lever in detent or full-lift position. Secure the implement for transport by installing Cylinder Stops or Transport Pin on pull-type implement center axle and Wing Transport Locks on folding implements.



- Attach Safety Chain to cutter and towing unit securely. See Operator's Manual.

6. Make certain that SMV sign, Warning Lights, and Reflectors are clearly visible. Follow local traffic codes.

7. Never operate with Cutting Head raised if passersby, bystanders, or traffic are in the area to reduce possibility of injury or death from objects thrown by Blades under Guards or cutter structure.

8. Before dismounting, secure implement in transport position or lower to ground.

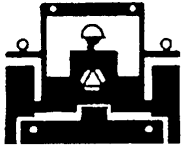
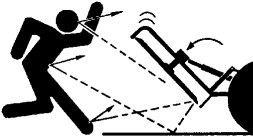
- Put tractor in park or set brake, disengage PTO, stop engine, and remove key, and wait until noise of rotation has ceased to prevent entanglement in rotating parts which can cause injury or death.
- Never mount or dismount a moving vehicle. Crushing from runover may cause injury or death.

<p>5. TRANSPORT SAFELY, CARRY LOW TO GROUND</p> 	<p>6. USE SMV, LIGHTS, & REFLECTORS.</p> 	<p>7. DO NOT OPERATE WITH CUTTER RAISED.</p> 	<p>8. DO NOT MOUNT OR DISMOUNT WHILE MOVING.</p> 
---	--	---	--

00777519

WARRANTY INFORMATION:

Read and understand the complete Warranty Statement found in this Manual. Fill out the Warranty Registration Form in full and return it to within 30 Days. Make certain the Serial Number of the Machine is recorded on the Warranty Card and on the Warranty Form that you retain.

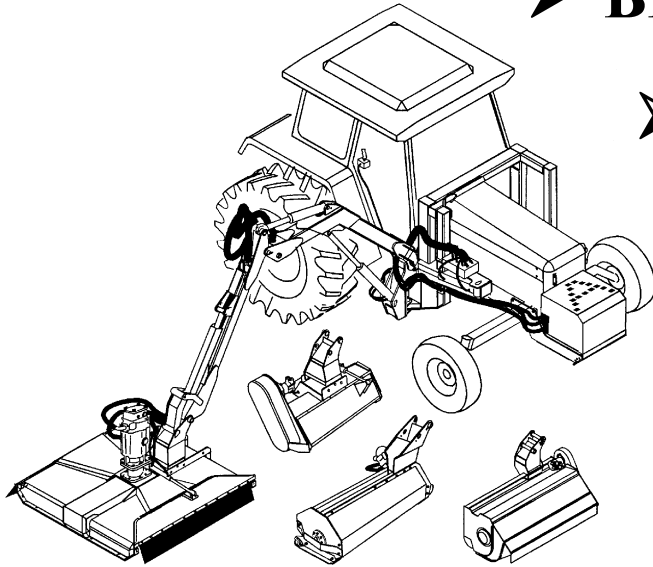

➤ **BE SAFE!**

➤ **BE ALERT!**

➤ **BE ALIVE!**

➤ **BE TRAINED
before operating
the Mower!**

**ALAMO
INDUSTRIAL**

*Safety Training
Makes the Difference*

In order to reduce accidents and enhance the safe operation of mowers, *Alamo Industrial*, in cooperation with other industry manufacturers has developed the AEM/FEMA Industrial and Agricultural Mower Safety Practices video and guide book.

The video will familiarize and instruct mower-tractor operators in safe practices when using industrial and agricultural mowing equipment. It is important that Every Mower Operator be educated in the operation of their mowing equipment and be able to recognize the potential hazards that can occur while operating a mower. This video, along with the mower operator's manual and the warning messages on the mower, will significantly assist in this important education.

Your Authorized *Alamo Industrial* Dealer may have shown this video and presented you a DVD Video when you purchased your mower. If you or any mower operator have not seen this video, **Watch the Video, Read this Operator's Manual, and Complete the Video Guidebook** before operating your new mower. If you do not understand any of the instructions included in the video or operator's manual or if you have any questions concerning safety of operation, contact your supervisor, dealer or *Alamo Industrial*.

If you would like a VHS video tape of the video, please email AEMVideo@alamo-group.com or Fax AEM VHS Video at (830) 372-9529 or mail in a completed copy of the form on the back of this page to AEM VHS Video 1502 E Walnut Street, Seguin, TX 78155. and request the VHS video version. Please include your name, mailing address, mower model and serial number.

Every operator should be trained for each piece of equipment (Tractor and Mower), understand the intended use, and the potential hazards before operating the equipment.

**Alamo Industrial Division is willing to provide
one (1) AEM Mower Safety Practices Video**

- Please Send Me: VHS Format – AEM/FEMA Mower Operator Safety Video
 DVD Format – AEM/FEMA Mower Operator Safety Video
 Mower Operator’s Manual
 AEM Mower Operator’s Safety Manual

Requester Name _____ Phone: _____

Requester Address: _____

City _____

State _____

Zip Code _____

Mower Model: _____ Serial Number: _____

Date Purchased: _____ Dealer Salesperson: _____

Dealership Name: _____ Dealership Location: _____

Mail to:

AEM Video Services

1502 E Walnut street

Seguin, TX 78155

Or Fax to:

(830) 372-9529

Or Email to:

AEMVideo@alamo-group.com

TABLE OF CONTENTS

SAFETY SECTION	1-1
General Safety Instructions and Practices	1-2
Operator Safety Instructions and Practices	1-3
Equipment Operation Safety Instructions and Practices	1-5
Transporting Safety Instructions and Practices	1-11
Maintenance and Service Safety Instructions and Practices	1-13
Concluding Safety Instructions and Practices	1-15
Decal Location	1-16
Decal Description	1-18
Federal Laws and Regulations	1-25
INTRODUCTION SECTION	2-1
ASSEMBLY SECTION	3-1
PROPER TORQUE VALUES FOR FASTENERS	3-2
CONNECTING THE MOWER TO THE TRACTOR	3-2
Connecting the Mower Tongue to the Tractor	3-3
Safety Tow Chain	3-3
PUMP,SPEED INCREASER AND CUTTER ATTACHMENT	3-4
ATTACHING CYLINDER HOSES	3-5
ATTACHING ELECTRICAL CONNECTIONS	3-5
LEVELING UNIT	3-5
WINCH ASSEMBLY ATTACHMENT (OPTIONAL EQUIPMENT)	3-6
Three Spool Control Valve Installation (OPTIONAL EQUIPMENT)	3-6
TIRES AND WHEELS(OPTIONAL WHEEL CONFIGURATIONS)	3-7
OPERATION SECTION	4-1
Standard Equipment and Specifications	4-3
OPERATOR REQUIREMENTS	4-4
TRACTOR REQUIREMENTS	4-5
ROPS and Seat Belt	4-5
Tractor Safety Devices	4-5
Tractor Horsepower	4-5
Hydraulics	4-6
Front End Weight	4-6
Power Take Off (PTO)	4-6
GETTING ON AND OFF THE TRACTOR	4-7
Boarding the Tractor	4-7
Dismounting the Tractor	4-7
STARTING THE TRACTOR	4-8
CONNECTING THE MOWER TO THE TRACTOR	4-9
Connecting the Mower Tongue to the Tractor	4-9
Safety Tow Chain	4-10
Connecting Mower Hydraulic Lines to the Tractor	4-10
SETTING THE MOWER	4-11
Leveling Mower	4-12
Setting Deck Pitch	4-13
PRE-OPERATION INSPECTION AND SERVICE	4-13

Tractor Pre-Operation Inspection/Service	4-14
Mower Pre-Operation Inspection/Service	4-16
Cutting Component Inspection	4-21
DRIVING THE TRACTOR AND MOWER	4-22
Starting the Tractor	4-23
Brake and Differential Lock Setting	4-24
Operating the Mower Wings	4-24
Driving the Tractor and Mower	4-26
Crossing Ditches and Steep Inclines	4-27
OPERATING THE TRACTOR AND IMPLEMENT	4-28
Foreign Debris Hazards	4-29
Bystanders/Passersby Precautions	4-29
Engaging the Power Take Off (PTO)	4-30
PTO RPM and Ground Speed	4-31
Operating the Mower	4-31
Shutting Down the Implement	4-35
DISCONNECTING THE MOWER FROM THE TRACTOR	4-35
MOWER STORAGE	4-37
TRANSPORTING THE TRACTOR AND IMPLEMENT	4-38
Transporting on Public Roadways	4-39
Hauling the Tractor and Implement	4-41
TROUBLESHOOTING GUIDE	4-42
 MAINTENANCE SECTION	 5-1

DAILY MAINTENANCE	5-2
Lubrication	5-3
WHEEL HUB ASSEMBLY	5-4
Tongue	5-4
Hydraulic Fluid	5-5
Proper Oil Level	5-5
Oil Level Low	5-5
Breather Element	5-6
BLADES	5-6
Blade Servicing	5-6
BLADE SHARPENING	5-7
BLADE REMOVAL	5-7
BLADE CARRIER REMOVAL	5-8
BLADE CARRIER INSTALLATION	5-8
Spindle	5-8
Nuts & Bolts	5-8
Spindle Housing Bolts -	5-9
Motor Bolts	5-9
Speed Changer Bolts	5-9
Pump Bolts	5-9
Axle Arm Bolts	5-9
Winch Stand Bolts	5-9
Drawbar Bolt	5-9
Blade Carrier Retaining Nut	5-9
Wheel Bearing Seal Inspection	5-10
Hydraulic Cylinders and Hoses	5-10
Cylinder Rod Maintenance	5-10
Clean The Machine	5-10
WEEKLY MAINTENANCE	5-11
Spindle Housing	5-12

Speed Changer	5-12
Chain Guard Bolts	5-12
Pins	5-12
Hinge Pins -	5-13
Lift Level Rods	5-13
Wheel Bearing	5-13
Chain Guards	5-14
Winch & Cable	5-14
Paint	5-15
BI-ANNUAL MAINTENANCE	5-15
Skid Shoes	5-15
Tongue Bolt	5-15
Drawbar Bolt	5-16
Level Lift System	5-16
Filter Change	5-16
Oil Change	5-16
Weld Inspection	5-17

SAFETY SECTION

Safety Section 1-1

SAFETY

General Safety Instructions and Practices

A careful operator is the best operator. Safety is of primary importance to the manufacturer and should be to the owner/operator. Most accidents can be avoided by being aware of your equipment, your surroundings, and observing certain precautions. The first section of this manual includes a list of Safety Messages that, if followed, will help protect the operator and bystanders from injury or death. Read and understand these Safety Messages before assembling, operating or servicing this Implement. This equipment should only be operated by those persons who have read the manual, who are responsible and trained, and who know how to do so responsibly.



The Safety Alert Symbol combined with a Signal Word, as seen below, is used throughout this manual and on decals which are attached to the equipment. The Safety Alert Symbol means: "ATTENTION! BECOME ALERT! YOUR SAFETY IS INVOLVED!" The Symbol and Signal Word are intended to warn the owner/operator of impending hazards and the degree of possible injury faced when operating this equipment.

Practice all usual and customary safe working precautions and above all---remember safety is up to YOU. Only YOU can prevent serious injury or death from unsafe practices.



Indicates an imminently hazardous situation that, if not avoided, WILL result in DEATH OR VERY SERIOUS INJURY.



Indicates an imminently hazardous situation that, if not avoided, COULD result in DEATH OR SERIOUS INJURY.



Indicates an imminently hazardous situation that, if not avoided, MAY result in MINOR INJURY.



Identifies special instructions or procedures that, if not strictly observed, could result in damage to, or destruction of the machine, attachments or the environment.

NOTE: *Identifies points of particular interest for more efficient and convenient operation or repair.* (SG-1)

READ, UNDERSTAND, and FOLLOW the following Safety Messages. Serious injury or death may occur unless care is taken to follow the warnings and instructions stated in the Safety Messages. Always use good common sense to avoid hazards. (SG-2)



Si no lee ingles, pida ayuda a alguien que si lo lea para que le traduzca las medidas de seguridad. (SG-3)

¡ LEA EL INSTRUCTIVO!



Engine Exhaust, some of its constituents, and certain vehicle components contain or emit chemicals known to the state of California to cause cancer and birth defects or other reproductive harm. (SG-30)

SAFETY



Battery posts, terminals and related accessories contain lead and lead compounds, chemicals known to the state of California to cause cancer, birth defects or other reproductive harm. (SG-31)

Operator Safety Instructions and Practices



The rotating parts of this machine continue to rotate even after the PTO has been turned off. The operator should remain in his seat for 60 seconds after the brake has been set, the PTO disengaged, the tractor turned off, and all evidence of rotation has ceased. (S3PT-10)

“Wait a minute...Save a life!”



Never crawl under a raised Implement supported solely by the Tractor 3-Point hitch. Release of the control lever or mechanical failure will result in the Implement falling and possible injury or death. Always securely block up the Implement before crawling underneath to perform repairs and service. (S3PT-19)



Never operate the Tractor or Implement until you have read and completely understand this Manual, the Tractor Operator's Manual, and each of the Safety Messages found in the Manual or on the Tractor and Implement. Learn how to stop the tractor engine suddenly in an emergency. Never allow inexperienced or untrained personnel to operate the Tractor and Implement without supervision. Make sure the operator has fully read and understood the manuals prior to operation. (SG-4)

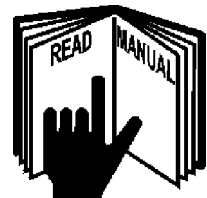

The operator and all support personnel should wear hard hats, safety shoes, safety glasses, and proper hearing protection at all times for protection from injury including injury from items that may be thrown by the equipment. (SG-16)

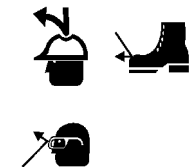

PROLONGED EXPOSURE TO LOUD NOISE MAY CAUSE PERMANENT HEARING LOSS! Tractors with or without an Implement attached can often be noisy enough to cause permanent hearing loss. We recommend that you always wear hearing protection if the noise in the Operator's position exceeds 80db. Noise over 85db over an extended period of time will cause severe hearing loss. Noise over 90db adjacent to the Operator over an extended period of time will cause permanent or total hearing loss. **NOTE:** *Hearing loss from loud noise [from tractors, chain saws, radios, and other such sources close to the ear] is cumulative over a lifetime without hope of natural recovery.* (SG-17)



SAFETY

SAFETY



Always read carefully and comply fully with the manufacturer's instructions when handling oil, solvents, cleansers, and any other chemical agent. (SG-22)



KEEP AWAY FROM ROTATING ELEMENTS to prevent entanglement and possible serious injury or death. (SG-24)



Never allow children to play on or around Tractor or Implement. Children can slip or fall off the Equipment and be injured or killed. Children can cause the Implement to shift or fall crushing themselves or others. (SG-25)



NEVER use drugs or alcohol immediately before or while operating the Tractor and Implement. Drugs and alcohol will affect an operator's alertness and coordination and therefore affect the operator's ability to operate the equipment safely. Before operating the Tractor or Implement, an operator on prescription or over-the-counter medication must consult a medical professional regarding any side effects of the medication that would hinder their ability to operate the Equipment safely. NEVER knowingly allow anyone to operate this equipment when their alertness or coordination is impaired. Serious injury or death to the operator or others could result if the operator is under the influence of drugs or alcohol. (SG-27)



Prolonged operation may cause operator boredom and fatigue affecting safe operation. Take scheduled work breaks to help prevent these potentially impaired operating conditions. Never operate the Implement and Tractor in a fatigued or bored mental state which impairs proper and safe operation. (SG-32)



Use extreme caution when getting onto the Implement to perform repairs, maintenance and when removing accumulated material. Only stand on solid flat surfaces to ensure good footing. Use a ladder or raised stand to access high spots which cannot be reached from ground level. Slipping and falling can cause serious injury or death. (SG-33)



Avoid contact with hot surfaces including hydraulic oil tanks, pumps, motors, valves and hose connections. Relieve hydraulic pressure before performing maintenance or repairs. Use gloves and eye protection when servicing hot components. Contact with a hot surface or fluid can cause serious injury from burns or scalding. (SG-34)

SAFETY



DO NOT operate this Implement on a Tractor that is not properly maintained. Should a mechanical or Tractor control failure occur while operating, immediately shut down the Tractor and perform repairs before resuming operation. Serious injury and possible death could occur from not maintaining this Implement and Tractor in good operating condition. (SG-36)



Avoid contact with hot surfaces of the engine or muffler. Use gloves and eye protection when servicing hot components. Contact with a hot surface or fluid can cause serious injury from burns or scalding. (SG-38)



Do not put hands or feet under mower decks. Blade Contact can result in serious injury or even death. Stay away until all motion has stopped and the decks are securely blocked up. (SGM-09)

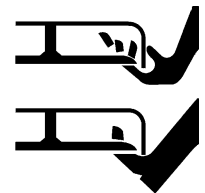

Always keep a careful lookout and use extreme care when working around utility and municipal obstructions. Never allow the Mower to contact any utility, municipal, or other type structure. Clearly mark all mowing obstructions and consult local utility providers for a safe code of operation. (SPU-5)



Do not operate the implement while wearing loose fitting clothing. Entanglement of the clothing with the rotating elements can result in serious injury or even death. Stay clear of all rotating elements at all times. (SSP-03)

Equipment Operation Safety Instructions and Practices



Never leave the Tractor and Implement unattended while the Implement is in the lifted position. Accidental operation of lifting lever or a hydraulic failure may cause sudden drop of unit with injury or death by crushing. To properly park the implement when disconnecting it from the tractor, lower the stand and put the retaining pin securely in place, or put a secure support under the A-Frame. Lower the implement carefully to the ground. Do not put hands or feet under lifted components. (S3PT-1)



Use extreme care when lowering or unfolding the implement's wings. Make sure no bystanders are close by or underneath the wings. Allow ample clearance around the implement when folding or unfolding the wings. Use extreme caution around buildings or overhead power lines. (S3PT-05)



This Implement is wider than the Tractor. Be careful when operating or transporting this equipment to prevent the Implement from running into or striking sign posts, guard rails, concrete abutments or other solid objects. Such an impact could cause the Implement and Tractor to pivot violently resulting in loss of steering control, serious injury, or even death. Never allow the Implement to contact obstacles. (S3PT-12)

SAFETY

SAFETY

DANGER

Be sure you have adequate knowledge of the property you will be working on. Take time to make yourself aware of any area underground lines or cables. Contact with buried lines or cable could result in **serious injury** or **death**. If in doubt about buried utility lines call 811 before digging or 1-800-258-0808. (SBH-6)

WARNING

Do not operate Mower if excessive vibration exists. Shut down PTO and the Tractor engine. Inspect the Mower to determine the source of the vibration. If Mower blades are missing or damaged replace them immediately. Do not operate the mower until the blades have been replaced and the Mower operates smoothly. Operating the Mower with excessive vibration can result in component failure and broken objects to be thrown outward at very high velocities. To reduce the possibility of property damage, serious injury, or even death, never allow the Mower to be operated with blades missing. (SFL-4)

WARNING

Operate this Equipment only with a Tractor equipped with an approved roll-over-protective system (ROPS). Always wear seat belts. Serious injury or even death could result from falling off the tractor--particularly during a turnover when the operator could be pinned under the ROPS. (SG-7)



DANGER

BEFORE leaving the tractor seat, always engage the brake and/or set the tractor transmission in parking gear, disengage the PTO, stop the engine, remove the key, and wait for all moving parts to stop. Place the tractor shift lever into a low range or parking gear to prevent the tractor from rolling. Never dismount a Tractor that is moving or while the engine is running. Operate the Tractor controls from the tractor seat only. (SG-9)

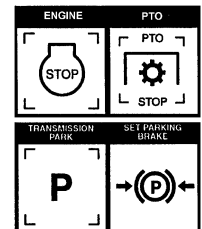

DANGER

Never allow children or other persons to ride on the Tractor or Implement. Falling off can result in serious injury or death. (SG-10)



DANGER

Never allow children to operate, ride on, or come close to the Tractor or Implement. Usually, 16-17 year-old children who are mature and responsible can operate the implement with adult supervision, if they have read and understand the Operator's Manuals, been trained in proper operation of the tractor and Implement, and are physically large enough to reach and operate the controls easily. (SG-11)



WARNING

Do not mount or dismount the Tractor while the tractor is moving. Mount the Tractor only when the Tractor and all moving parts are completely stopped. (SG-12)



SAFETY

DANGER

Start tractor only when properly seated in the Tractor seat. Starting a tractor in gear can result in injury or death. Read the Tractor operators manual for proper starting instructions. (SG-13)



WARNING

Do not operate this Equipment with hydraulic oil or fuel leaking. Oil and fuel are explosive and their presence could present a hazard. Do not check for leaks with your hand! High-pressure oil streams from breaks in the line could penetrate the skin and cause tissue damage including gangrene. To check for a hose leak, SHUT the unit ENGINE OFF and remove all hydraulic pressure. Wear oil impenetrable gloves, safety glasses and use Cardboard to check for evidence of oil leaks. If you suspect a leak, REMOVE the HOSE and have it tested at a Dealer. If oil does penetrate the skin, have the injury treated immediately by a physician knowledgeable and skilled in this procedure. (SG-15)



DANGER

Never run the Tractor engine in a closed building or without adequate ventilation. The exhaust fumes can be hazardous to your health. (SG-23)

WARNING

Do not exceed the rated PTO speed for the Implement. Excessive PTO speeds can cause Implement driveline or blade failures resulting in serious injury or death. (SG-26)

DANGER

Operate the Tractor and/or Implement controls only while properly seated in the Tractor seat with the seat belt securely fastened around you. Inadvertent movement of the Tractor or Implement may cause serious injury or death. (SG-29)

WARNING

In case of mechanical difficulty during operation, place the transmission in the park position, set the parking brake, shut down all power, including the PTO and the engine and remove the key. Wait until all rotating motion has stopped before dismounting. (SG-39)

SAFETY

SAFETY

WARNING

Do Not operate this equipment in areas where insects such as bees may attack you and/or cause you to lose control of the equipment. If you must enter in such areas, use a tractor with an enclosed Cab and close the windows to prevent insects from entering. If a tractor cab is not available, wear suitable clothing including head, face, and hand protection to shield you from the insects. Attacking insects can cause you to lose control of the tractor, which can result in serious injury or death to you or bystanders. Never dismount a moving tractor. (SG-40)

WARNING

Mow only in conditions where you have clear visibility in daylight or with adequate artificial lighting. Never mow in darkness or foggy conditions where you cannot clearly see at least 100 yards(90 m) in front and to the sides of the tractor and mower. Make sure that you can clearly see and identify passersby, steep slopes, ditches, drop-offs, overhead obstructions, power lines, debris and foreign objects. If you are unable to clearly see these type of items discontinue mowing. (SGM-1)

DANGER

There are obvious and hidden potential hazards in the operation of this Mower. REMEMBER! This machine is often operated in heavy brush and in heavy weeds. The Blades of this Mower can throw objects if shields are not properly installed and maintained. Serious injury or even death may occur unless care is taken to insure the safety of the operator, bystanders, or passersby in the area. Do not operate this machine with anyone in the immediate area. Stop mowing if anyone is within 100 yards of mower. (SGM-02)



DANGER

The rotating parts of this machine have been designed and tested for rugged use. However, the blades could fail upon impact with heavy, solid objects such as metal guard rails and concrete structures. Such impact could cause the broken objects to be thrown outward at very high velocities. To reduce the possibility of property damage, serious injury, or even death, never allow the cutting blades to contact such obstacles. (SGM-4)

WARNING

Extreme care should be taken when operating near loose objects such as gravel, rocks, wire, and other debris. Inspect the area before mowing. Foreign objects should be removed from the site to prevent machine damage and/or bodily injury or even death. Any objects that cannot be removed must be clearly marked and carefully avoided by the operator. Stop mowing immediately if blades strike a foreign object. Repair all damage and make certain rotor or blade carrier is balanced before resuming mowing. (SGM-05)



WARNING

Many varied objects, such as wire, cable, rope, or chains, can become entangled in the operating parts of the mower head. These items could then swing outside the housing at greater velocities than the blades. Such a situation is extremely hazardous and could result in serious injury or even death. Inspect the cutting area for such objects before mowing. Remove any like object from the site. Never allow the cutting blades to contact such items. (SGM-06)

SAFETY

WARNING

Mow at the speed that you can safely operate and control the tractor and mower. The correct mowing speed depends on terrain condition and grass type, density, and height of cut. Normal ground speed range is from 2 to 5 mph(3-8 kph). Use slow mowing speeds when operating on or near steep slopes, ditches, drop-offs, overhead obstructions, power lines, or when debris and foreign objects are to be avoided. (SGM-07)

WARNING

Avoid mowing in reverse direction when possible. Check to make sure there are no persons behind the mower and use extreme care when mowing in reverse. Mow only at a slow ground speed where you can safely operate and control the tractor and mower. Never mow an area that you have not inspected and removed debris or foreign material. (SGM-08)

WARNING

Do not mow with two machines in the same area except with Cab tractors with the windows closed. (SGM-11)

WARNING

Follow these guidelines to reduce the risk of equipment and grass fires while operating, servicing, and repairing the Mower and Tractor:



- Equip the Tractor with a fire extinguisher in an accessible location.
- Do Not operate the Mower on a Tractor with an underframe exhaust.
- Do Not smoke or have an open flame near the Mower and Tractor.
- Do Not drive into burning debris or freshly burnt areas.
- Ensure slip clutches are properly adjusted to prevent excessive slippage and plate heating.
- Never allow clippings or debris to collect near drivelines, slip clutches, and gearboxes. Periodically shut down the Tractor and Mower and clean clippings and collected debris from the mower deck. (SGM-12)

DANGER

The Mower is designed for certain mowing applications and is rated to cut up to a specific size vegetation (see Mower Standard Equipment and Specifications). DO NOT use this mower to cut vegetation above the Mower's rated capacity or to cut any type of non-vegetative material. Only operate this Mower on a properly sized and equipped Tractor. Operating this Mower in an application for which it is not designed and/or operating the Mower with the wrong size Tractor can cause Mower component damage and equipment failure resulting in possible serious injury or death. (SGM-14)

WARNING

Do not operate or pull the mower into standing water. When uplift or fan type mower blades contact water they can be severely deflected downward causing possible failure of blade resulting in serious injury to the operator or bystanders. (SGM-15)

SAFETY

DANGER

Use extreme caution when raising the Mower above ground level. Stop the Blades from turning when the Mower is raised and passersby are within 100 yards. Raising the Mower exposes the Cutting Blades which creates a potentially serious hazard and can cause serious injury by objects thrown from the Blades or by contact with the Blades. (SPU-1)

DANGER

Rotary Mowers are capable under adverse conditions of throwing objects for great distances (300 feet or more) and causing serious injury or death. Follow safety messages carefully.



STOP MOWING IF PASSERSBY ARE WITHIN 100 YARDS UNLESS:

- Front and Rear Deflectors, Chain Guards, or Bands are installed and in good, workable condition;
- Mower sections or Wings are running close to and parallel to the ground without exposed Blades;
- Passersby are outside the existing thrown-object zone;
- All areas have been thoroughly inspected and all foreign material such as rocks, cans, glass, and general debris has been removed.

NOTE: Where there are grass and weeds high enough to hide debris that could be struck by the blades, the area should be: inspected and large debris removed, mowed at an intermediate height, inspected, closely with any remaining debris being removed, and mowed again at desired final height. (This will also reduce power required to mow, reduce wear and tear on the Mower drivetrain, spread cut material better, reduce streaking, and make the final cut more uniform). (SRM-01)

DANGER

Do not turn so sharp or lift mower so high to produce a severe "knocking" of the Driveline which will cause accelerated wear and breakage of drive train components and could result in possible injury from the separated Driveline sections. (SRM-04)

WARNING

Do not let the Blades turn when the Mower Deck is raised for any reason, including clearance or for turning. Raising the Mower deck exposes the Cutting Blades which creates a potentially serious hazard and could cause serious injury or even death from objects thrown from the Blades. (SRM-07)



Connecting or Disconnecting Implement Safety Instructions and Practices

SAFETY



DO NOT use a PTO adapter to attach a non-matching Implement driveline to a Tractor PTO. Use of an adapter can double the operating speed of the Implement resulting in excessive vibration, thrown objects, and blade and implement failure. Adapter use will also change the working length of the driveline exposing unshielded driveline areas. Serious bodily injury and/or equipment failure can result from using a PTO adapter. Consult an authorized dealer for assistance if the Implement driveline does not match the Tractor PTO.

(S3PT-14)



Always shut the Tractor completely down, place the transmission in park, and set the parking brake before you or anyone else attempts to connect or disconnect the Implement and Tractor hitches. (S3PT-15)



Never operate the Tractor and Mower if the Implement input driveline is directly connected to the Tractor transmission. Tractor braking distances can be substantially increased by the momentum of the rotating Mower blades driving the Tractor transmission even though the Tractor clutch has been disengaged. Install an over running clutch between the Tractor PTO and the Mower driveline to prevent this potentially dangerous situation. (S3PT-16)



When attaching the Implement input driveline to the Tractor PTO, it is important that the connecting yoke spring activated locking collar slides freely and the locking balls are seated securely in the groove on the Tractor PTO shaft. Push and pull the driveline back and forth several times to ensure it is securely attached. A driveline not attached correctly to the Tractor PTO shaft could come loose and result in personal injury and damage to the Implement. (S3PT-17)



Before operating the Implement, check to make sure the Implement input driveline will not bottom out or become disengaged. Bottoming out occurs when the inner shaft penetrates the outer housing until the assembly becomes solid-it can shorten no more. Bottoming out can cause serious damage to the Tractor PTO by pushing the PTO into the Tractor and through the support bearings or downward onto the PTO shaft, breaking it off. A broken driveline can cause personal injury. (S3PT-18)

Transporting Safety Instructions and Practices



Be particularly careful when transporting the Implement with the Tractor. Turn curves or go up hills only at a low speed and using a gradual steering angle. Rear mounted implements move the center of gravity to the rear and remove weight from the front wheels. Make certain, by adding front ballast, that at least 20% of the tractor's weight is on the front wheels to prevent rearing up, loss of steering control or Tractor tip-over. Slow down on rough or uneven surfaces to prevent loss of steering control which could result in property damage or possible injury. Do not transport unless 3-Point lift lever is fully raised and in the latched transport position. Dropping implement in transport can cause serious damage to the tractor and/or Implement and possibly cause the operator or others to be injured or killed.

(S3PT-02)

SAFETY

WARNING

Allow sufficient clearance for the Implement to swing outward while turning. Implements carried behind the Tractor will swing outside the tire path when making turns. Contacting a solid object while turning will cause equipment damage and possible injury. (S3PT-20)

WARNING

Make certain that the "Slow Moving Vehicle" (SMV) sign is installed in such a way as to be clearly visible and legible. When transporting the Equipment use the Tractor flashing warning lights and follow all local traffic regulations. (SG-6)

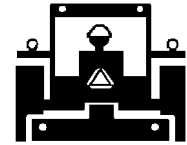

WARNING

Transport only at speeds where you can maintain control of the equipment. Serious accidents and injuries can result from operating this equipment at high speeds. Understand the Tractor and Implement and how it handles before transporting on streets and highways. Make sure the Tractor steering and brakes are in good condition and operate properly.



Before transporting the Tractor and Implement, determine the proper transport speeds for you and the equipment. Make sure you abide by the following rules:

Test the tractor at a slow speed and increase the speed slowly. Apply the Brakes smoothly to determine the stopping characteristics of the Tractor and Implement. As you increase the speed of the Tractor the stopping distance increases. Determine the maximum transport speed not to exceed 20 mph (30 kph) for transporting this equipment.

Test the equipment at a slow speed in turns. Increase the speed through the turn only after you determine that the equipment can be operated at a higher speed. Use extreme care and reduce your speed when turning sharply to prevent the tractor and implement from turning over. Determine the maximum turning speed for you and this equipment before operating on roads or uneven ground.



Only transport the Tractor and Implement at the speeds which allow you to properly control the equipment.

Be aware of the operating conditions. Do not operate the Tractor with weak or faulty brakes or worn tires. When operating down a hill or on wet or rain slick roads, the braking distance increases: use extreme care and reduce your speed. When operating in traffic always use the Tractor's flashing warning lights and reduce your speed. Be aware of traffic around you and watch out for the other guy. (SG-19)

DANGER

Be particularly careful when transporting the Implement using the tractor. Turn curves or go up or down hills only at a low speed and at a gradual steering angle. Make certain that at least 20% of the tractor's weight is on the front wheels to maintain safe steering. Slow down on rough or uneven surfaces. (STI-01)

SAFETY

WARNING

Only tow the Implement behind a properly sized and equipped Tractor which exceeds the weight of the Implement by at least 20%. DO NOT tow the Implement behind a truck or other type of vehicle. Never tow the Implement and another Implement connected in tandem. Never tow the Implement at speeds over 20 MPH. (STI-06)



WARNING

Your driving vision may be reduced or impaired by the tractor, cab, or implement. Before driving on public roadways identify any limited vision areas, and make adjustments to your operating position, mirrors, and the implement transport position so that you can clearly see the area where you will be traveling, and any traffic that may approach you. Failure to maintain adequate vision of the public roadway and traffic can result in serious injury or even death. (STI-10)

Maintenance and Service Safety Instructions and Practices

DANGER

Make sure the PTO shield, integral driveline shields, and input shields are installed when using PTO-driven equipment. Always replace any shield if it is damaged or missing. (S3PT-8)



WARNING

Relieve hydraulic pressure prior to doing any maintenance or repair work on the Implement. Place the Implement on the ground or securely blocked up, disengage the PTO, and turn off the tractor engine. Push and pull the Remote Cylinder lever in and out several times prior to starting any maintenance or repair work. (S3PT-09)



DANGER

Always disconnect the main PTO Driveline from the Tractor before performing service on the Implement. Never work on the Implement with the tractor PTO driveline connected and running. Rotating Parts, Blades or Drivelines could turn without warning and cause immediate entanglement, injury or death. (S3PT-11)

WARNING

Always maintain the safety signs in good readable condition. If the safety signs are missing, damaged, or unreadable, obtain and install replacement safety signs immediately. (SG-5)

WARNING

Do not modify or alter this Implement. Do not permit anyone to modify or alter this Implement, any of its components or any Implement function. (SG-8)

DANGER

Never work under the Implement, the framework, or any lifted component unless the Implement is securely supported or blocked up to prevent sudden or inadvertent falling which could cause serious injury or even death. (SG-14)



SAFETY

SAFETY



WARNING Never attempt to lubricate, adjust, or remove material from the Implement while it is in motion or while tractor engine is running. (SG-20)



WARNING Periodically inspect all moving parts for wear and replace when necessary with authorized service parts. Look for loose fasteners, worn or broken parts, and leaky or loose fittings. Make sure all pins have cotter pins and washers. Serious injury may occur from not maintaining this machine in good working order. (SG-21)

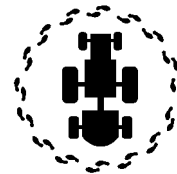

DANGER Do Not fill fuel tank while engine is running. Refuel only after engine has cooled down. If fuel is spilled, move machine away from the area of the spill and avoid creating any source of ignition until the gasoline has evaporated. (SG-28)



WARNING Perform service, repairs and lubrication according to the maintenance section. Ensure the unit is properly lubricated as specified in the lubrication schedule and all bolts and nuts are properly torqued. Failure to properly service, repair and maintain this Implement in good operating condition could cause component failure and possible serious injury or even death. (SG-35)



WARNING Use caution and wear protective gloves when handling sharp objects such as blades, knives, and other cutting edges. Be alert to worn component surfaces which have sharp edges. Sharp surfaces can inflict severe laceration injuries if proper hand protection is not worn. (SG-37)



DANGER All Safety Shields, Guards and Safety devices including (but not limited to) - the Deflectors, Chain Guards, Steel Guards, Gearbox Shields, PTO integral shields, and Retractable Door Shields should be used and maintained in good working condition. All safety devices should be inspected carefully at least daily for missing or broken components. Missing, broken, or worn items must be replaced at once to reduce the possibility of injury or death from thrown objects, entanglement, or blade contact. (SGM-3)

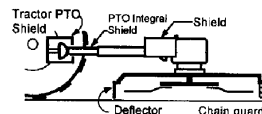

DANGER Replace bent or broken blades with new blades. NEVER ATTEMPT TO STRAIGHTEN, WELD, OR WELD HARDFACING ON BLADES SINCE THIS WILL LIKELY CRACK OR OTHERWISE DAMAGE THE BLADE WITH SUBSEQUENT FAILURE AND POSSIBLE SERIOUS INJURY FROM THROWN BLADES. (SGM-10)

SAFETY



DO NOT weld or repair rotating mower components. Welds and other repairs may cause severe vibration and/or component failure resulting in part being thrown from the mower causing serious bodily injury. See your Authorized Dealer for proper repairs. (SGM-13)

PARTS INFORMATION

Alamo Industrial mowers use balanced and matched system components for blade carriers, blades, cuttershafts, knives, knife hangers, rollers, drivetrain components, and bearings. These parts are made and tested to Alamo Industrial specifications. Non-genuine "will fit" parts do not consistently meet these specifications. The use of "will fit" parts may reduce mower performance, void mower warranties, and present a safety hazard. Use genuine Alamo Industrial mower parts for economy and safety. (SPRM-1)

SEE YOUR ALAMO DEALER



Be sure you have adequate knowledge of the property you will be working on. Take time to make yourself aware of any area underground lines or cables. Contact with buried lines or cable could result in **serious injury** or **death**. (STL-1)



In wet conditions where there is a likelihood of material collecting on the Implement, make certain that this material is removed before traveling on public roadways. (STL-7)

Concluding Safety Instructions and Practices

In addition to the design and configuration of this Implement, including Safety Signs and Safety Equipment, hazard control and accident prevention are dependent upon the awareness, concern, prudence, and proper training of personnel involved in the operation, transport, maintenance, and storage of the machine. Refer also to Safety Messages and operation instruction in each of the appropriate sections of the Tractor and Equipment Manuals. Pay close attention to the Safety Signs affixed to the Tractor and Equipment. (SG-18)

SAFETY

Decal Location

NOTE: Alamo Industrial supplies safety decals on this product to promote safe operation. Damage to the decals may occur while in shipping, new Romang, use, or reconditioning. Alamo Industrial cares about the safety of its customers, operators, and bystanders, and will replace the safety decals on this product in the field, free of charge (Some shipping and handling charges may apply). Contact your Alamo Industrial dealer to order replacement decals.

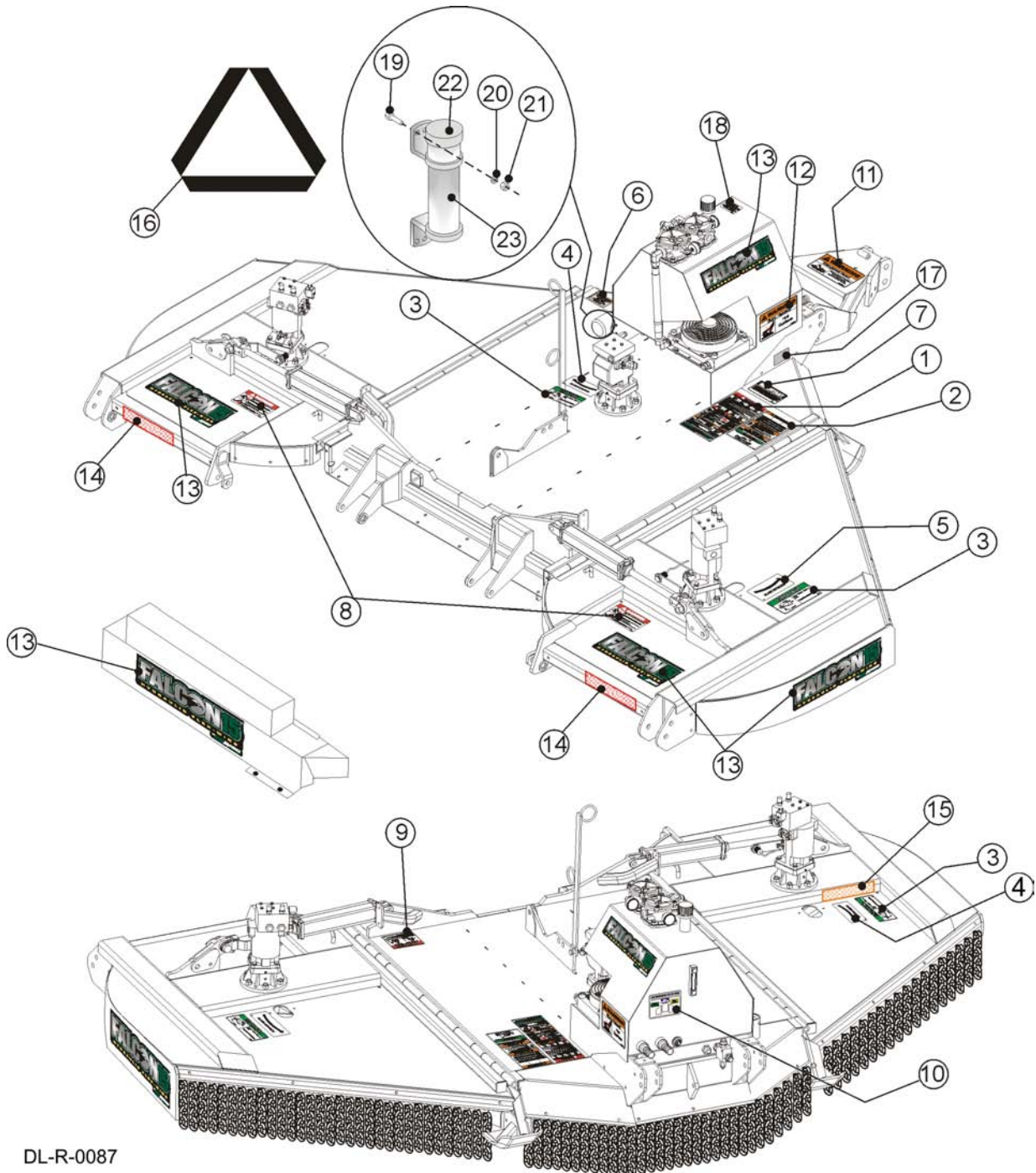

DL-R-0087

SAFETY

SAFETY

ITEM	PART NO.	QTY	LEVEL	DESCRIPTION
1.	D389	1	DANGER	Multiple Hazard
2.	D390	1	DANGER	Multiple Hazard Pull Unit
3.	D395	3	IMPORTANT	Replace Blades In Pairs
4.	D138	2(1)	INSTRUCT	CW Blade Rotation
5.	D137	1(1)	INSTRUCT	CCW Blade Rotation
6.	D103	[1]	WARNING	540 PTO Speed
	D114	[1]	WARNING	1000 PTO Speed
7.	02925100	1	IMPORTANT	Genuine Alamo Parts
8.	00753840	2	DANGER	Folding Wing, Thrown Objects
9.	999403	(1)	DANGER	Overturn of Two-Section Flex
10.	02985907	1	INSTRUCT	Color Coded Hose Connect
11.	02985912	1	WARNING	Replace Master PTO Shield
12.	02985911	1	WARNING	Hot Surface
13.	02985904	[6](5)	LOGO	FALCON LOGO 15
	02985905	[6](5)	LOGO	FALCON LOGO 10
14.	1458392	2	REFLCTR	Red Reflectors
15.	1458393	1	REFLCTR	Amber Reflector
16.	03200347	*	REFLCTR	SMV
17.	nfs	1	Plate	Serial Number Plate
18.	02982828	1	INSTRUC	Hyd Oil
19.	10058000	3	_____	Bolt
20.	00024100	6	_____	Flatwasher
21.	02953324	3	_____	Locknut
22.	00776031	1	_____	Canister, Operators Manual
23.	02985378C	1	_____	Operators Manual

*Furnished by Tractor manufacturer

[] Quantity for two-section unit

() Quantity if left wing not used

{ } Quantity if right wing not used

SAFETY

Decal Description

Multi Hazard Decal Sheet



P/N D389

Decal D389 consists of the following multi-hazards.

SAFETY

⚠ DANGER			
FAILING TO FOLLOW SAFETY MESSAGES AND OPERATING INSTRUCTIONS CAN CAUSE SERIOUS BODILY INJURY OR EVEN DEATH TO OPERATOR AND OTHERS IN THE AREA.			
1. READ MANUAL 	2. NO RIDERS, NO CHILDREN OPERATORS 	3. USE SAFETY SHOES, HARD HAT, SAFETY GLASSES, SEAT BELTS, & HOOD 	4. BLOCK UP SECURELY BEFORE WORKING UNDER
<p>1. Study and understand operator's manual, safety signs, and instructional decals for tractor and implement to prevent misuse, abuse, and accidents.</p> <ul style="list-style-type: none"> Learn how to stop engine suddenly in an emergency. Be alert for passerby and especially children. <p>2. Allow no children on or near implement or tractor. Allow no riders on tractor and implement. Falling off may cause serious injury or death from being run over by tractor or cutter or contact with rotating blades.</p> <p>3. Operate only with tractor having Roll-Over Protective Structure (ROPS) and with seatbelt fastened securely and snugly to prevent injury and possible death from falling off or tractor overturn. Personal Protective Equipment such as Hard Hat, Safety Glasses, Safety Shoes, and Ear Plugs are Recommended.</p> <p>4. Block up or support raised machine and all lifted components securely before putting hands or feet under or working underneath any lifted components to prevent crushing injury or death from sudden dropping or inadvertent operation of controls. Make certain area is clear before lowering or folding.</p> <p>5. Before transporting, put Lift Lever in detent or full-lift position. Secure the implement for transport by installing Cylinder Stops or Transport Pin on Pull-type implement center axle and Wing Transport Locks on folding implements.</p> <ul style="list-style-type: none"> Attach Safety Chain to cutter and towing unit securely. See Operator's Manual. <p>6. Make certain that the SMV sign, Warning Lights, and Reflectors are clearly visible. Follow local traffic codes.</p> <p>7. Never operate with Cutting Head raised if passerby, bystanders, or traffic are in the area to reduce possibility of injury or death from Objects Thrown by Blades Under Guard or cutter structure.</p> <p>8. Before dismounting, secure implement in transport position or lower to ground.</p> <ul style="list-style-type: none"> Put tractor in park or set the brake, disengage PTO, stop engine, and remove key, and wait until noise of rotation has ceased to prevent entanglement in rotating parts which can cause injury or death. Never mount or dismount a moving vehicle. Crushing from rollover may cause injury or death. 			
6. TRANSPORT SAFELY, LOCK UP 	8. USE SMV LIGHTS & REFLECTORS 	7. DO NOT OPERATE WITH CUTTER OR WING RAISED 	5. DO NOT MOUNT OR DISMOUNT WHILE MOVING

⚠ DANGER	
KEEP AWAY - THROWN OBJECTS	
	<ul style="list-style-type: none"> Inspect the area before mowing for potential mower hazards. Remove or avoid all foreign objects such as wire, cable, metal objects, and all other foreign material. Foreign material can be thrown from the mower and cause serious bodily injury to the operator and passerby.
	<ul style="list-style-type: none"> Do Not let rotating blades contact solid objects like rocks, posts, curbs or guard rails. Operate only if all Guards-Deflectors are in place and in good condition.
	<ul style="list-style-type: none"> Do Not operate with Mower or Wing raised off the ground. Stop mowing if Passersby enter the area of thrown objects. (See Operator's Manual)
	<ul style="list-style-type: none"> Stay away from rotating blades. Keep hands and feet away from rotating blades. Do Not approach mower until all motion has stopped.

⚠ WARNING	
FAILURE TO USE AND MAINTAIN SHIELDS AND DEFLECTORS IN GOOD CONDITION MAY LEAD TO INJURY OR DEATH FROM ENTANGLEMENT WITH ROTATING PARTS, BEING HIT BY OBJECTS THROWN WITH GREAT FORCE BY BLADES, OR BY BLADE CONTACT.	
	Always replace Guards which have been removed for maintenance. Never operate with Guards missing or broken.
	Chain Guards, Gearbox & Driveline Shields, Rubber-Fabric Deflectors, and Solid Band Enclosures are subject to wear and lost or broken parts and must be repaired or replaced as soon as damage is found.
	Safety Shielding must be installed and in good condition to reduce the possibility of thrown objects anytime this machine is operated in any area where thrown objects could cause property damage or bodily injury.

⚠ WARNING	
BE AWARE BE ALERT BE ALIVE	BE TRAINED BEFORE OPERATING THIS CUTTER
To prevent serious injury to yourself and/or bystanders, be trained in Safe Mowing Practices.	
Alamo Group Companies, A1, M&W, Rhino, Schulte, and Tiger provide training material that is critical for your Safety and the Safety of others when operating this equipment. Make these Safety Procedures an important part of every workday.	
Read and understand the Operator's Manual	
Do not let untrained individuals operate this equipment.	
Contact your Dealer, AEM (www.aem.org) or Alamo Group (www.Alamo-Group.com) for information on training material or courses that provide training in Safer Operating Practices for Cutters.	

⚠ PELIGRO
LEA EL INSTRUCTIVO
Si No lee Ingles, Pida Ayuda a Alguien Que Se Lo Lea Para Que Le Traduzca las Medidas de Seguridad.

IMPORTANT
An OPERATOR'S MANUAL (with Repair Parts Listing) and a WARRANTY REGISTRATION CARD were attached to this implement during final inspection at the factory. If they were not attached at the time of purchase, please contact your selling dealer at once.

SAFETY

Multi Hazard Decal Sheet

P/N D390

Decal D390 consists of the following multi-hazards.



WARNING

DO NOT OPERATE EQUIPMENT WITH OIL LEAKS

1. High pressure fluid can be invisible and can be injected into the body through the skin. Serious injury or even death can result. A doctor familiar with this type of injury must surgically remove the injected fluid immediately.
2. You should visually inspect for hydraulic fluid leaks before using the equipment. Never use your hand to check for leaks. Wear oil impervious gloves, safety glasses, and use a piece of wood or cardboard to check for evidence of leaks. If you suspect a leak, Remove the hose and have it tested at a Dealer.
3. Inspect hoses regularly. Frayed, torn, or crimped hoses may rupture suddenly and violently resulting in serious bodily injury from a flying hose end or from scalding, burn injuries, or oil penetration. Oil sprayed on hot equipment or components can result in fire. Repair or replace hoses as indicated to prevent unexpected failure and possible serious injury to operator or bystanders.

KEEP SHIELDS OVER HYDRAULIC COMPONENTS IN PLACE.

WARNING

1. DO NOT transport at speed above 20 mph. Exceeding 20 mph decreases braking ability and may cause loss control and serious personal injury.
2. ONLY transport behind a properly sized and equipped tractor. NEVER tow behind a truck or other motor vehicle. ALWAYS properly fasten the implement safety tow chain to the tractor.
3. Reduce speed on inclines, while turning, and when towing in adverse conditions.
4. ENSURE a SMV emblem can be clearly seen from behind the unit. Turn ON the tractor flashing warning lights when transporting.

WARNING

Keep Mower Deck Clear of Debris

There is a risk of Fire when dry material accumulates and contacts heat generated from rotating components. See Operator's Manual for fire prevention.

IMPORTANT

REQUIRED FOR STANDARD PULL TYPE UNIT

Attach Safety Chain securely as per ASAE S338

SAFETY

SAFETY

IMPORTANT! Always replace blades in pairs.

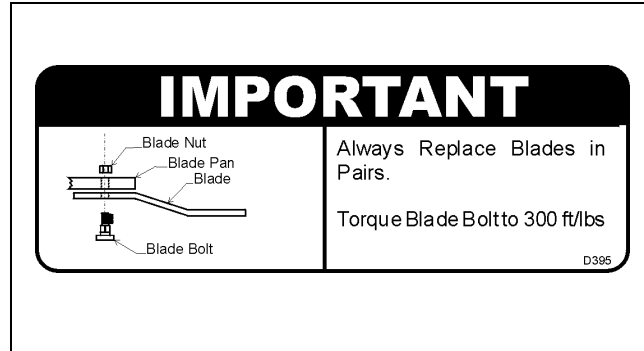

P/N D395

Blade Rotation Clockwise.

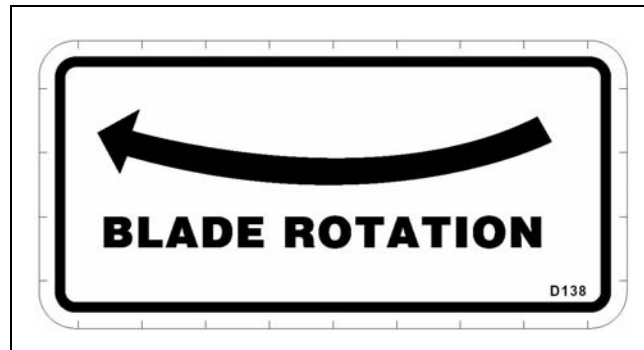

P/N D138

Blade Rotation Counter Clockwise.

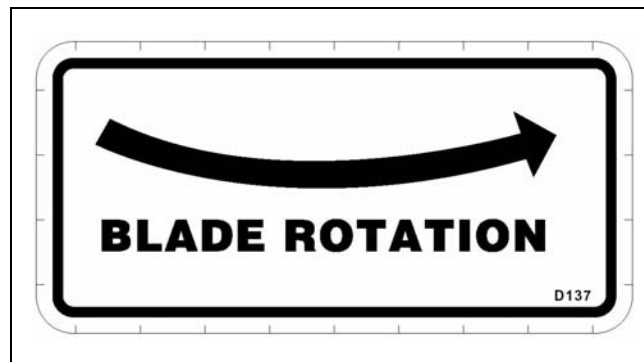

P/N D137

WARNING! Avoid Bodily Injury, Use 540RPM PTO Speed Only.



P/N D103

SAFETY

SAFETY

WARNING! Avoid Bodily Injury, Use 1000 RPM PTO Speed Only.

P/N D114



IMPORTANT - Use only Genuine Alamo Industrial replacement parts.

P/N 02925100



DANGER! Stay clear when lowering or raising wings.

P/N 00753840

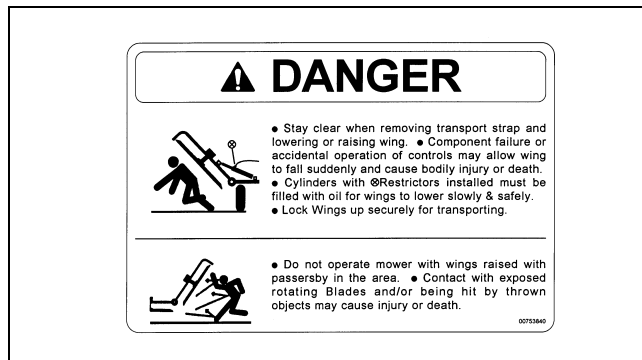

DANGER! Keep everyone clear when lifting, folding, and working under raised components. Block securely before working under mower. Install Weight Box and Weight (Min. of 700lbs) before operating to prevent turning over the center section which can cause SERIOUS BODILY INJURY or DEATH. Without weight, Do not fold wing. Attach transport strap securely to prevent inadvertent dropping from the transport position and possible CRUSHING INJURY OR DEATH.
P/N 999403

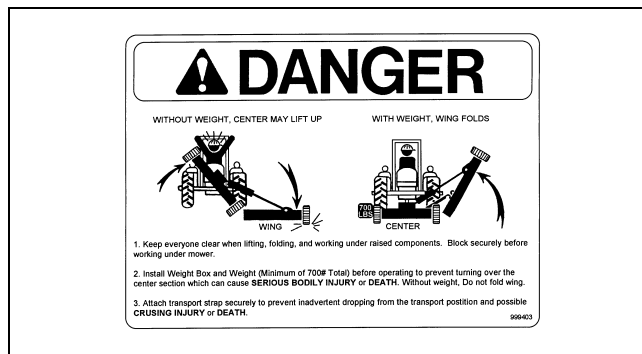

SAFETY

SAFETY

SAFETY

INSTRUCT- Cylinder Hose Color Code

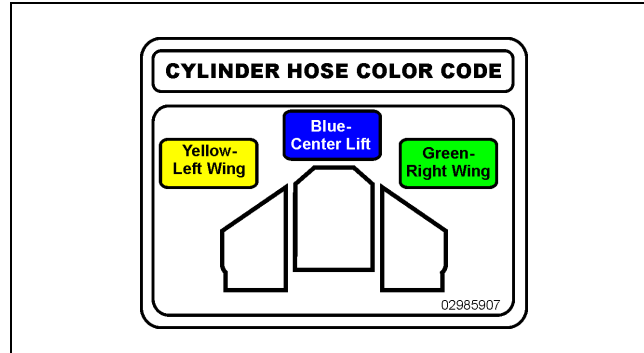

P/N 02985907

WARNING- Entanglement Hazard- Replace master PTO shield after disconnecting Implement from tractor.



P/N 02985912

WARNING- Burn Hazard- Hot Surface DO NOT touch.



P/N 02985911

LOGO- FALCON 15 LOGO



P/N 02985904

SAFETY

LOGO- FALCON 10 LOGO



P/N 02985905

Red Reflector. Keep reflectors clean and visible.

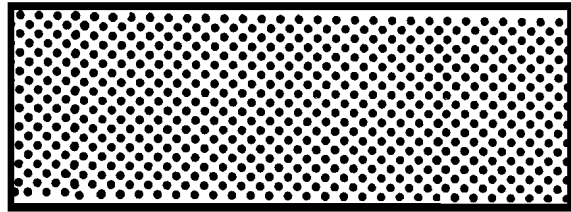

P/N 1458392

Amber Reflector. Keep reflectors clean and visible.

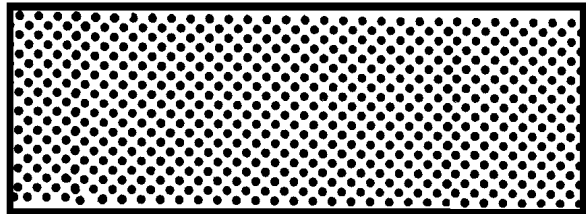

P/N 1458393

Slow Moving Vehicle Decal. Keep SMV reflector clean and visible. DO NOT transport or operate without the SMV.

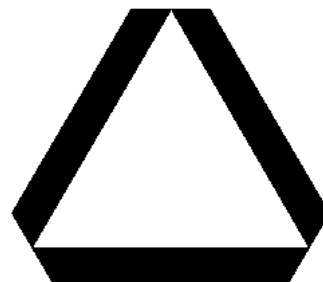

P/N 03200347

SAFETY

SAFETY

INSTRUCT - Service hydraulic system with proper oil.

P/N 02982828

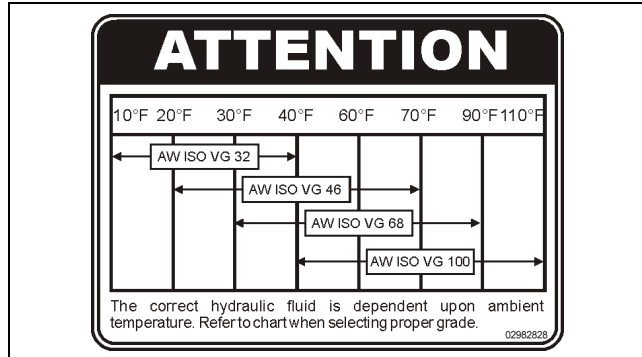

SAFETY

SAFETY

Federal Laws and Regulations

This section is intended to explain in broad terms the concept and effect of federal laws and regulations concerning employer and employee equipment operators. This section is not intended as a legal interpretation of the law and should not be considered as such.

Employer-Employee Operator Regulations

U.S. Public Law 91-596 (The Williams-Steiger Occupational and Health Act of 1970) OSHA

This Act Seeks:

“...to assure so far as possible every working man and woman in the nation safe and healthful working conditions and to preserve our human resources...”

DUTIES

Sec. 5 (a) Each employer-

- (1) shall furnish to each of his employees employment and a place of employment which are free from recognized hazards that are causing or are likely to cause death or serious physical harm to his employees;
- (2) shall comply with occupational safety and health standards promulgated under this Act.
- (b) Each employee shall comply with occupational safety and health standards and all rules, regulations and orders issued pursuant to this Act which are applicable to his own actions and conduct.

OSHA Regulations

OSHA regulations state in part: “At the time of initial assignment and at least annually thereafter, the employer shall instruct every employee in the safe operation and servicing of all equipment with which the employee is, or will be involved.”

Employer Responsibilities:

To ensure employee safety during Tractor and Implement operation, it is the employer’s responsibility to:

1. Train the employee in the proper and safe operation of the Tractor and Implement.
2. Require that the employee read and fully understand the Tractor and Implement Operator’s manual.
3. Permit only qualified and properly trained employees to operate the Tractor and Implement.
4. Maintain the Tractor and Implement in a safe operational condition and maintain all shields and guards on the equipment.
5. Ensure the Tractor is equipped with a functional ROPS and seat belt and require that the employee operator securely fasten the safety belt and operate with the ROPS in the raised position at all times.
6. Forbid the employee operator to carry additional riders on the Tractor or Implement.
7. Provide the required tools to maintain the Tractor and Implement in a good safe working condition and provide the necessary support devices to secure the equipment safely while performing repairs and service.
8. Require that the employee operator stop operation if bystanders or passersby come within 25 feet.

Child Labor Under 16 Years of Age

Some regulations specify that no one under the age of 16 may operate power machinery. It is your responsibility to know what these regulations are in your own area or situation. (Refer to U.S. Dept. of Labor, Employment Standard Administration, Wage & Home Division, Child Labor Bulletin #102.)



Safety Manual

*For Operators
and Mechanics*

Industrial/ Agricultural Mower

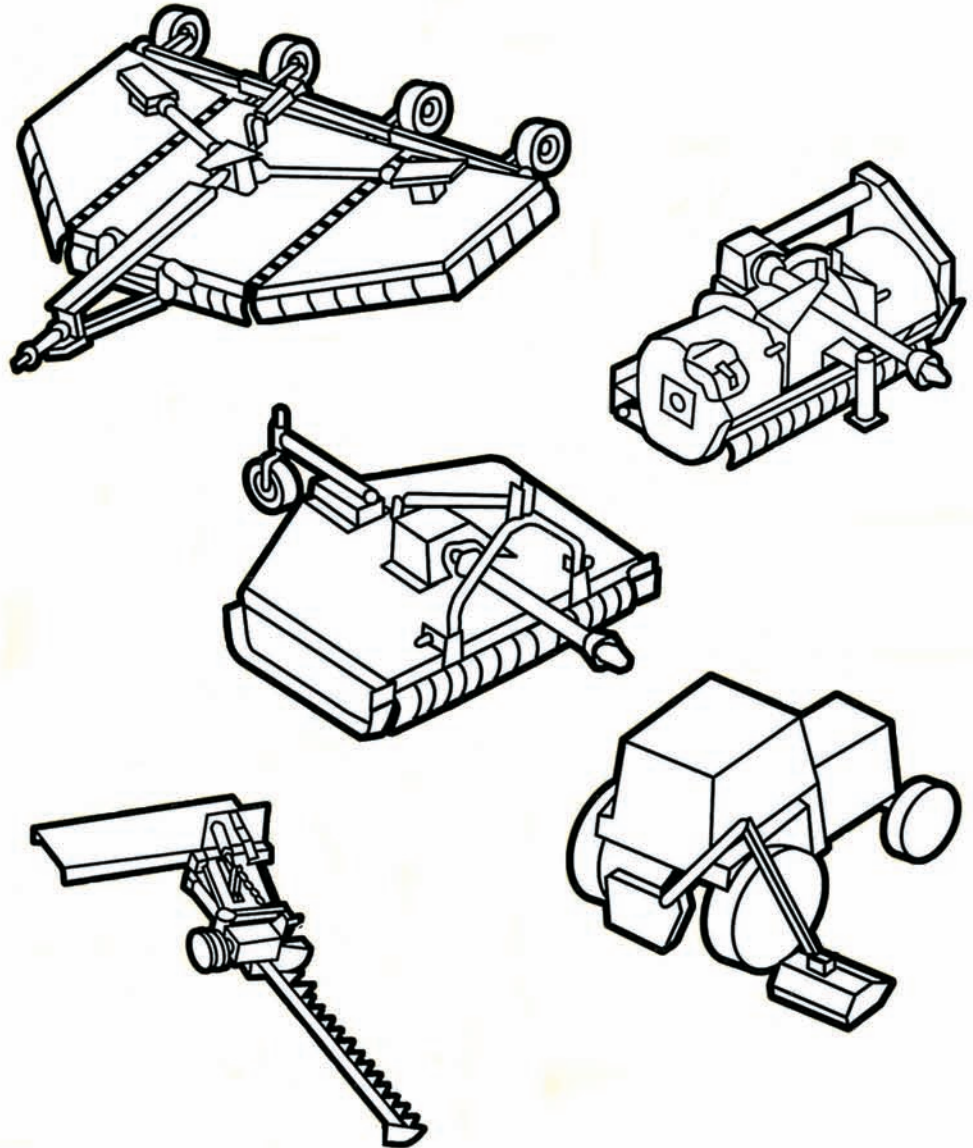

111 E. Wisconsin Avenue • Milwaukee, Wisconsin 53202 U.S.A.
www.aem.org

Contents

Acknowledgement	2
Forward	3
A Word to the User	3
Safety Alert Symbol	4
Industrial/Agricultural Mower Types	4
Be a Responsible Operator	5
Safety Management of Hazards and Risks	6
Follow a Safety Program	11
Safety-Before Operation	11
Safety-Starting and Testing	13
Safety-During Operation	14
Safety-During Shutdown	18
Safety-During Maintenance	19
One Final Word	21

Acknowledgement

We wish to acknowledge the contributions of the members of the Association of Equipment Manufacturers to the preparation of this Safety Manual.

Copyright
© 2000 AEM (formerly Equipment Manufacturers Institute). Revised 08.2003. All rights reserved.

Forward

This Safety Manual is intended to point out some of the basic safety situations which may be encountered during the normal operation and maintenance of your machine and to suggest possible ways of dealing with these conditions. This manual is NOT a substitute for the manufacturer's manual(s).

Additional precautions may be necessary, or some instructions may not be applicable, depending on the equipment, attachment devices, and conditions at the worksite or in the service area. The manufacturer has no direct control over machine application, operation, inspection, lubrication, or maintenance. Therefore, it is **YOUR** responsibility to use good safety practices in these areas.

The information provided in this manual supplements the specific information about your machine that is contained in the manufacturer's manual(s). Other information which may affect the safe operation of your machine may be contained on safety signs or in insurance requirements, employer's safety and training programs, safety codes, local, state/provincial and national laws, rules and regulations.

IMPORTANT: *If you do not have the manufacturer's manual(s) for your particular machine, get a replacement manual from your employer, equipment dealer, or the manufacturer of your machine. Keep this safety manual and the manufacturer's manual(s) with your machine.*

A Word to the User

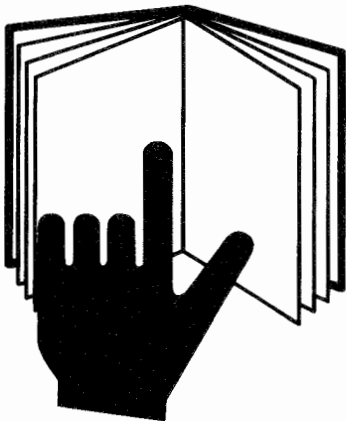

It is your responsibility to read and understand this safety manual and the manufacturer's manual(s) before operating this machine. This safety manual takes you step-by-step through your working day. The safety manual, manufacturer's manual(s), safety signs (decals) and safety precautions must be explained to those users or operators who cannot read the material.

In addition to equipment design and configuration, **HAZARD CONTROL** and **ACCIDENT PREVENTION** are dependent upon the owner's and operator's awareness, concern, prudence, and proper training in the operation, transport, maintenance and storage of equipment.

Remember that **YOU** are the key to safety. Good safety practices not only protect you but also protect the people around you. Study this manual and the manufacturer's manual(s) for your specific machine. Make them a working part of your safety program. Keep in mind that this safety manual is written only for industrial and agricultural mowers.

Practice all usual and customary safe working precautions and above all – remember safety is up to YOU. Only YOU can prevent serious injury or death from unsafe practices.

Safety Alerts

Symbol

This Safety Alert Symbol means:

**“ATTENTION! BECOME ALERT!
YOUR SAFETY IS INVOLVED!”**

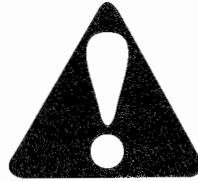

The Safety Alert Symbol identifies important safety messages on equipment, safety signs, in manuals or elsewhere. When you see this symbol, be alert to the possibility of death or personal injury. Follow the instructions in the safety message.

Signal Words

Signal words are distinctive words that will typically be found on safety decals on this equipment or other equipment on the worksite. These words are intended to alert the viewer to the existence and relative degree of a hazard.



This signal word indicates an imminently hazardous situation which, not avoided, will result in death or serious injury.



This signal word indicates a potentially hazardous situation which, if not avoided, could result in death or serious injury.



This signal word indicates a potentially hazardous situation exists which, if not avoided, may result in minor or moderate injury.

- ACCIDENTS DISABLE AND KILL.
- ACCIDENTS COST.
- ACCIDENTS CAN BE AVOIDED.

Industrial/Agricultural Mowers

A mower for pasture clipping, crop residue shredding, heavy brush cutting for land clearing, waterways, right-of-ways, road side or highway mowing.

INDUSTRIAL/AGRICULTURAL MOWER TYPES:

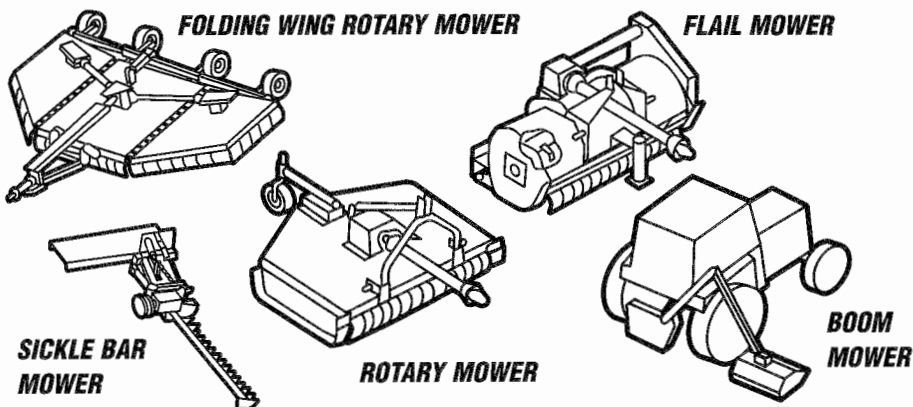

Be a Responsible Operator



For safe operation of your equipment, you must be a responsible operator. A responsible operator must clearly understand the written instructions supplied by the manufacturer, be trained—including actual operation of the equipment and know the safety rules and regulations for the worksite.

Drugs and alcohol will affect an operator's alertness and coordination and therefore affect the operator's ability to operate the equipment safely. An operator should **NEVER** use drugs which affect alertness, judgement and coordination or alcohol while operating motorized equipment, including tractors and mowers. An operator on prescription or over-the-counter medication must consult a medical professional regarding any side effects of the medication that would hinder his or her ability to operate this equipment safely. **NEVER** knowingly allow anyone to operate this equipment when their alertness, judgement or coordination is impaired.

Protect Yourself

Wear all the protective clothing and personal safety devices issued to you or called for by job conditions.

You may need:

- Hard hat
- Safety shoes
- Safety glasses with side shields, goggles or face shield
- Heavy gloves
- Hearing protection
- Reflective clothing
- Wet weather gear
- Respirator or filter mask



Wear adequate clothing for the job conditions.

Always know where to get assistance in the case of an emergency. Know where to find and how to use a first aid kit and fire extinguisher/fire suppression system.

**Stay alert. Avoid accidents.
Don't learn safety the hard way.**

Safety Management of Hazards and Risks

In addition to equipment design and configuration, **HAZARD CONTROL** and **ACCIDENT PREVENTION** are dependent upon the owner's and operator's awareness, concern, prudence, and proper training in the operation, transport, maintenance and storage of equipment.

SAFETY MANAGEMENT OF HAZARDS AND RISKS IS ESSENTIAL TO RESPONSIBLE OWNERS AND OPERATORS OF TRACTORS AND MOWERS.

REVIEW THE FOLLOWING SAFETY MANAGEMENT OF LISTED HAZARDS AND RISKS:

Thrown Object Hazard

POSSIBLE THROWN OBJECT INJURY RISKS EXIST FOR MOWER OPERATORS AND BYSTANDERS DURING MOWER OPERATIONS FROM THE FOLLOWING:

DISCHARGED OBJECTS (ROCKS, DEBRIS, BROKEN MOWER BLADES, BLADE BOLTS, CABLES, CHAINS, WIRE, ETC....) FROM THE MOWER.

Equipment Protective Devices And Recommended Safety Practices

The mower deck and protective devices cannot prevent all objects or debris from escaping the blade enclosure area in every mowing condition. It is possible for objects to escape and travel several hundred (300) feet.

RECOMMENDED SAFETY PRACTICES

Read manufacturer's operator manual(s) for recommended operating safety practices. Explain the practices to users or operators who cannot read.

TO HELP PREVENT SERIOUS INJURY OR DEATH FROM OBJECTS STRIKING OPERATOR OR OTHER PERSONS DO THE FOLLOWING:

BYSTANDERS SAFETY

- Keep bystanders several hundred (300) feet from mowing area.

EQUIPMENT PROTECTIVE DEVICES SAFETY

To contain, deflect or reduce thrown objects from blade enclosure area:

- Keep chain, flexible or solid deflector shields in place on the front and rear of the mower deck and in good repair.
- Do not operate with damaged or missing thrown object shielding.

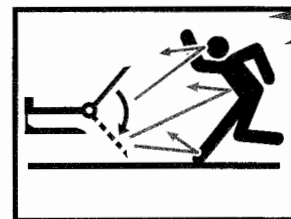
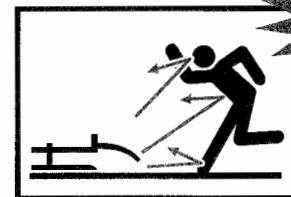
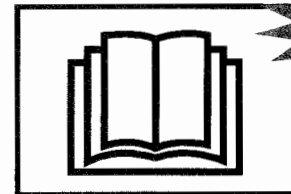
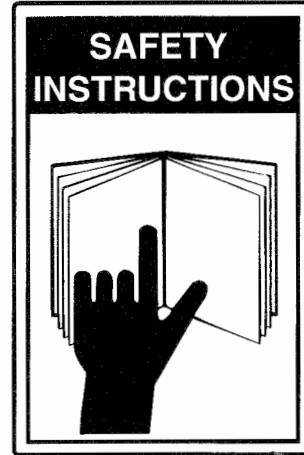

THROWN Object Hazard

READ Manuals

KEEP Bystanders Away

THROWN Object Hazard

**USE ROPS
Enclosed Cabs
or Protective
Enclosures**

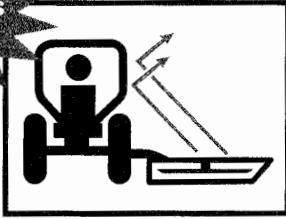

**USE Proper
PTO Speed**

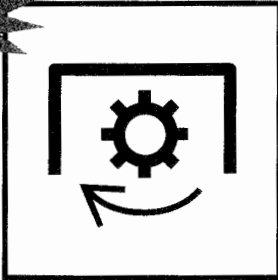

**MAINTAIN
Equipment**

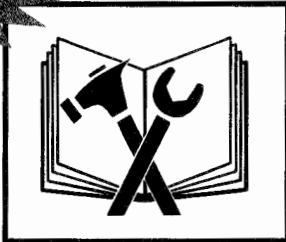

OPERATOR SAFETY

Raised wings, side mount and boom type mower operations may reduce the mower's thrown object shielding effectiveness for the mower operator's protection.

Do the following to increase operator protection from thrown objects during these mowing operations:

- Use enclosed ROPS cabs, special protective enclosures, screens or other operator shielding devices when performing these operations.

EXCEEDING RECOMMENDED PTO SPEEDS

Do not exceed manufacturer's recommended PTO speeds.

Excessive PTO speeds may cause:

- Blade failures
- Higher velocity objects escaping or broken blades being thrown from mower blade enclosures.
- Potential 540 rpm driveline failures operating at 750 to 1000 rpm speeds.

OTHER SAFETY PRACTICES:

- Never operate mower with broken, bent, missing, or severely worn blades.
- Before mowing, remove debris and foreign objects to avoid them being picked up and thrown out by the mower.
- * Do not operate the mower in transport or in raised wing positions.

RECOMMENDED MAINTENANCE PRACTICES

Read manufacturer's operator manual(s) inspection and maintenance instructions for chain guards, flexible or solid deflector shielding:

- Replace worn or damaged guards and other shielding before mowing.
- Use only manufacturer's replacement guards and shielding. Other guarding or shielding sources may not fit or have inadequate materials to meet the strength requirements of the equipment.
- Replace worn or damaged decals and warning instructions.
- Explain the inspection and maintenance instructions to those users or operators who cannot read.

Rotating Blades and Driveline Hazards and Risks

A POSSIBLE INJURY RISK EXISTS TO MOWER OPERATORS AND BYSTANDERS DURING MOWING OPERATIONS FROM THE FOLLOWING:

- BODY CONTACT WITH ROTATING BLADES.
- BODY ENTANGLEMENT WITH ROTATING DRIVELINES AND PARTS.

Equipment Protective Devices and Recommended Safety Practices

RECOMMENDED SAFETY PRACTICES

Read manufacturer's operator manual(s) for recommended operating safety practices. Explain the practices to those users or operators who cannot read. To help prevent serious injury or death from moving blade contact, driveline or parts entanglement of operators or other persons do the following:

BYSTANDERS SAFETY

- Do not operate near bystanders.
- Keep other persons several hundred (300) feet from the mowing area.

OPERATOR SAFETY PRACTICES

- Do not allow riders on tractor or mower. Securely fasten seat belt when mowing.
- Use proper equipment shutdown practice before servicing, adjusting, cleaning or unclogging the mower.
- Keep clear of rotating blades, parts, and drivelines.
- Never start tractor engine while standing beside equipment.
- Only start tractor engine while sitting in operator's seat with seat belt fastened.

RECOMMENDED GUARDS, DRIVELINE GUARDS AND SHIELDING SAFETY PRACTICES

- Keep guards, driveline and other shielding in place and in good repair.
- Do not operate mower with missing or damaged guards, driveline guards or other shielding.

RECOMMENDED MAINTENANCE PRACTICES

Read manufacturer's operator manual(s) inspection and maintenance instructions for guards, driveline guards and other shielding:

- Replace worn or damaged guards, driveline guards and other shielding before mowing.
- Use only manufacturer's replacement guards and shielding. Other guarding or shielding sources may not fit or have inadequate materials to meet the strength requirements of the equipment.
- Replace worn or damaged decals and warning instructions.
- Explain the inspection and maintenance instructions to those users or operators who cannot read.

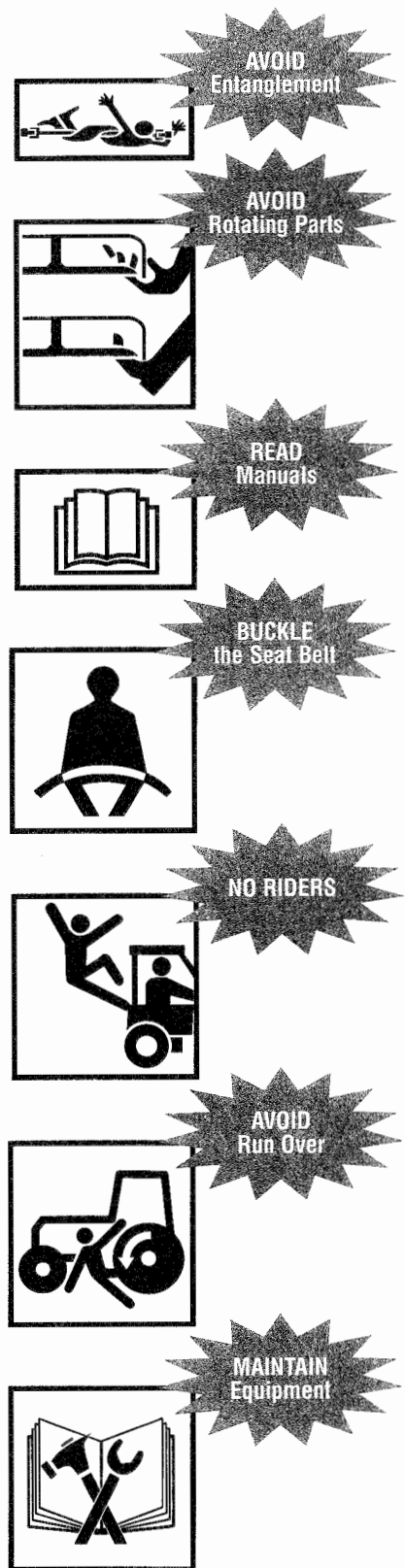

Tractor and Mower Rollover or Overturn Hazards and Risks

A POSSIBLE ROLLOVER OR OVERTURN INJURY RISK EXISTS TO MOWER OPERATORS DURING MOWING OPERATIONS FROM THE FOLLOWING:

- ROUGH TERRAIN, STEEP SLOPES, HOLES, BUMPS, RUTS, ROCKS, STUMPS OR OTHER OBSTRUCTIONS THAT COULD OVERTURN TRACTOR AND MOWER.
- EXCESSIVE GROUND SPEEDS FOR THESE TERRAIN CONDITIONS.

Equipment Protective Devices and Recommended Safety Practices

When possible remove stumps, stones, etc.. or mark them and other obstructions clearly to avoid upsets, breakdowns, and dangerous driving conditions. Use extreme care to maintain control over the equipment when operating in these terrain conditions.

RECOMMENDED-TRACTOR ROPS

A tractor equipped with ROPS or enclosed ROPS cab and seat belt for operator safety is essential for additional operator protection when operating mower in these terrain conditions.

RECOMMENDED-TRACTOR STABILITY ADJUSTMENTS

Read the tractor operator's manual for adjustments to increase tractor stability:

- Adding front and rear wheel weights or ballast.
- Adjusting wheel spacing to maximum width .
- Adding off-side counter ballast to side-mounted and boom mowers.
- Explain adjustments to those users or operators who cannot read.

RECOMMENDED SAFETY PRACTICES

Read manufacturer's operator manual(s) for recommended operating safety practices. Explain the practices to those users or operators who cannot read. **To help prevent serious injury or death to the operator from tractor and mower overturns, do the following:**

- Securely fasten seat belt when mowing with ROPS equipped tractors.
- Avoid excessive ground speed for terrain conditions.
- Avoid sudden starts, stops and turns when operating up, down or across slopes.
- Avoid slippery ground conditions.
- Make wide and gradual turns.
- Plan to mow down hill on steep slopes to avoid overturning.

Falling Mower or Parts Crushing Hazards and Risks

A POSSIBLE CRUSHING INJURY RISK EXISTS FOR MOWER OPERATORS AND OTHERS DURING MOWING OPERATIONS FROM THE FOLLOWING:

- FALLING MOWER OR EQUIPMENT FROM HYDRAULIC SYSTEM FAILURE.
- FAILURE TO SECURELY SUPPORT, BLOCK-UP OR LOCK-UP LIFTED MOWER OR EQUIPMENT PARTS.

**AVOID
Rollover**

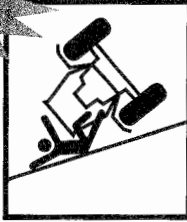

**USE
Tractor ROPS**



**READ
Manuals**

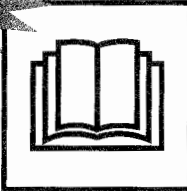

**ADD
Ballast**



**WIDEN
Wheel Spacing
and ADD Off-Side
Ballast**



**BUCKLE
the Seat Belt**



**AVOID
CRUSHING
Lock-Up Wing**



Equipment Protective Devices and Recommended Safety Practices

Read manufacturer's operator manual(s) for recommended operating safety practices. Explain the practices to those users or operators who cannot read. **To help prevent serious injury or death to operators and other from alling mower or equipment parts, do the following:**

RECOMMENDED SAFETY PRACTICES

Before working near or underneath lifted mower or equipment parts:

- Use proper equipment shutdown practices before servicing, adjusting, cleaning or unclogging the mower.
- Securely support or block-up raised mower or equipment parts.
- Securely support, block-up or lock-up wings with locking devices on wing type mowers or lower mower or equipment parts to the ground.
- Use transport locks when transporting mower on public roads.

High Pressure Hydraulic Fluid Leak Hazards and Risks

A POSSIBLE HIGH PRESSURE FLUID SKIN INJECTION INJURY AND GANGRENE RISK EXISTS FOR MOWER OPERATORS AND OTHERS FROM HIGH PRESSURE HYDRAULIC OR DIESEL OIL LEAK INJECTION INTO THE SKIN.

TO AVOID GANGRENE, INJECTED FLUID MUST BE SURGICALLY REMOVED WITHIN A FEW HOURS BY A DOCTOR FAMILIAR WITH THIS TYPE OF INJURY.

RECOMMENDED SAFETY PRACTICES

Read manufacturer's operator manual(s) for recommended operating safety practices. Explain the practices to those users or operators who cannot read. High pressure fluid pinhole leaks can be almost invisible.

To help prevent serious injury or death, do the following:

- Search for leaks with cardboard or wood.
- Do not use hands to check for leaks.
- Relieve system pressure before disconnecting lines.
- Before applying system pressure:
 - Check for damaged lines, pipes, and hoses.
 - Check to insure tight connections.
- Before operating pressurized systems:
 - Purge air from system.
 - Refer to the manufacturer's operator manual(s) for instructions.
 - Explain the procedures to those users or operators who cannot read.

Tractor Refueling Hazards and Risks

To avoid serious injury or death from fire during refueling:

- Shut off engine and ignition.
- Never fill fuel tank near open flames.
- Never smoke while refueling.
- Avoid static electricity sparks by grounding fuel nozzle against tank filler neck.
- Avoid overfilling tank or spilling fuel.
- Clean up any spilled fuel immediately.
- Always replace fuel cap.

To avoid serious injury or death from engine exhaust fumes:

- Adequately ventilate enclosed spaces before starting the engine.

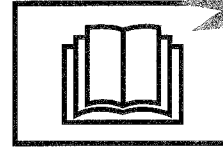

**READ
Manuals**

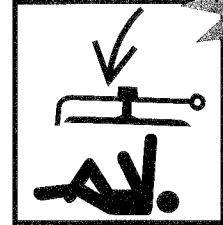

**AVOID
CRUSHING
Block-Up or
Securely Support
Mower**

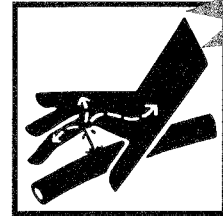

**HIGH
PRESSURE FLUID
Can Inject
into the Body**



**READ
Manuals**

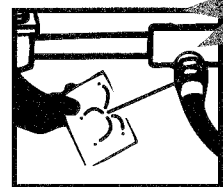

**AVOID
INJECTION
Use Cardboard
Not Hands**



**AVOID
Fires and
Explosions**

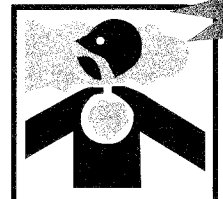

**AVOID
Exhaust Fumes**

Follow A Safety Program

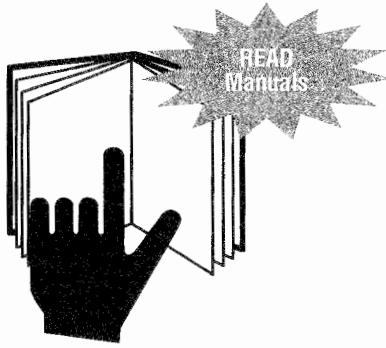

SAFETY IS IMPORTANT TO RESPONSIBLE OWNERS AND OPERATORS OF TRACTORS AND MOWERS. DO THE FOLLOWING FOR YOUR SAFE MOWING OPERATION:

BE A QUALIFIED OPERATOR BY:

- Reading, understanding and obeying the manufacturer's written instructions in operator manual(s) and safety signs on mower and tractor.
- Receiving operational training with mower and tractor.
- Asking your equipment dealer or supervisor to explain things you do not understand.
- Explaining the written instructions in the operator manual(s) and safety signs (decals) on the mower and tractor to those users or operators who cannot read.

Safety Before Operation

Know Job Site Safety Rules And Regulations

Ask your supervisor about equipment operation safety rules you will be expected to obey.

Some basic rules for your's and others' safety:

- A ROPS and seat belt equipped tractor is required for operator protection during mowing operations.
- Know mower and tractor operating capacity and characteristics.
- Never alter or remove safety equipment.
- Never allow children or unqualified persons to operate mower or tractor.
- Never allow riders on mower or tractor.
- Keep others away from mowing operation.
- Use proper equipment shutdown practice before dismounting tractor.
- Allow all moving parts to stop before making equipment inspections, repairs, or adjustments.
- Securely support or block-up mower before working beneath mower or lifted components.
- Wear personal protective clothing and safety devices issued to you or recommended by the equipment manufacturer.



Know Tractor And Mower Controls

Know the following about your tractor and mower:

- Function, purpose and use of controls.
- Safe operating speeds.
- Safe slope and uneven terrain capabilities.
- Braking and steering characteristics.
- Tractor and mower operating clearances.
- How to stop equipment quickly in an emergency.

Use All Available Equipment Safety Devices

To help keep you and others around you safe:

- Make certain manufacturer's recommended guards, shields and safety signs are installed on equipment and in good condition.
- Keep all protective devices in place and securely fastened.
- **NEVER** operate your equipment with missing, disconnected or damaged safety devices.
- Use ballast and weight required for equipment operational stability.

Check The Mower And Tractor Equipment

Before beginning your work day:

- Check for loose, broken, missing or damaged tractor and mower parts.
- Repair or replace these parts when needed.
- Check for proper tractor and mower attachments.
- Check for proper tractor and mower PTO rpm rating match.
- Check mower blades condition. Sharpen or replace per manufacturer's recommendation. Blade modifications, such as welding or hard surfacing cutting edges by welding or straightening bent blades, can reduce blade strength and adversely affect blade properties and safety.
- Check that all guards and shields are in place and that all equipment is in good operating condition. This includes PTO driveline, gearbox and implement guards and shields that are used for operator protection.
- Check for properly latched driveline yoke end locking devices.
- Check for damaged or leaky tractor and mower hydraulic systems.
- Check and read safety signs and warning instructions.
- Explain the safety signs and warning instructions to those users or operators who cannot read.

Check The Work Area

Inspect, identify and avoid hazardous conditions in the work area:

- Rough terrain, drop-offs, ditches, potholes steep slopes, stumps, standing water, mud soft soil, slippery conditions, debris and foreign objects.
- Inspect mowing area and remove or mark all foreign objects and debris to be avoided by mower.

Analyze mowing area to determine:

- Best and safest mowing procedure.
- Material type and height to be mowed.
- Operating terrain conditions.
- Using forward travel mowing pattern when possible.

Look Out For The Safety of Others

Before starting equipment:

- Walk around the equipment.
- Check for anyone under, on or near the equipment.
- Clear everyone from these areas.
- Sound a warning.



**USE ROPS
and Seatbelt**

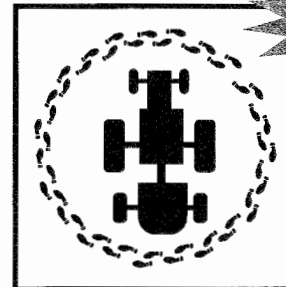

**WALK AROUND
Inspection**

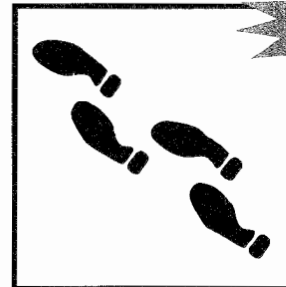

**WALK AROUND
the Worksite**

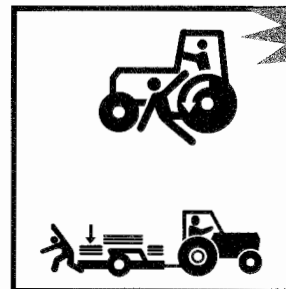

**LOOK OUT
For Others**

Safety – Starting & Testing

USE Three Point Contact



USE ROPS and Seatbelt



USE Proper PTO speed

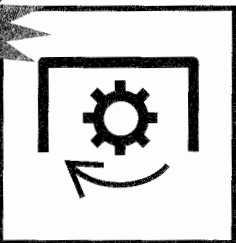

Mounting Tractor Safety

Before mounting:

- Clean shoes and wipe hands.

During mounting and dismounting:

- Use handholds and step plates.
- Never grab steering wheels or controls for handholds.
- Never mount or dismount from a moving tractor.

Tractor And Mower Controls Safety Test

Before starting:

- Fasten and adjust seat belt on your ROPS-equipped tractor.
- Check parking brake for engagement.
- Check PTO disengagement.
- Check all controls for Neutral or Park position.
- Warn others in area before starting tractor.
- Follow tractor manufacturer's recommended starting procedures.

After starting:

- Check all instruments, gauges and indicator lights for normal operation.
- Check all tractor controls, steering and brakes for proper function.
- Repair improperly functioning tractor before using.
- Raise and lower mower for driveline bottoming out or engagement problems.
- Check your equipment for excessive vibration and unusual noises.
- Use proper equipment shutdown practices before inspecting equipment.

Power Takeoff System And Mower Safety

Tractors with dual-speed (540 or 1000 rpm) shiftable PTO systems.

To avoid serious injury or death from failed parts due to mower over speed:

- Be sure to position PTO selector to mower's rated PTO rpm speed.

Tractors with transmission-driven PTO systems.

A rotary mower will have a significant flywheel effect which may continue to propel a tractor with a transmission-driven PTO system.

The tractor should be equipped and operated as follows:

- Install an over-running clutch.
- Give yourself sufficient maneuvering room and time by anticipating turns, stops and speed reductions.

Safety – During Operation

Hitching Mower To Tractor Safety

Three-point hitch-mounted mower safety:

- Refer to mower and tractor manufacturers' manuals.
- Place tractor's hydraulic power lift (rockshaft) selector lever in down position to avoid unexpected movement.
- Explain the hitching procedures to those users or operators who cannot read.

Pull-type hitch-mounted mower safety:

- Refer to mower and tractor manufacturers' manuals.
- Attach only to drawbar hitch.
- Do not attach to tractor's rear axle or three-point hitch arms.
- Adjust tractor drawbar length for 540 or 1000 rpm PTO operation.

Make The Right Start In Mower Safety

Mow only in daylight or good artificial light conditions.

To avoid serious injury or death from mower thrown objects or blade contact:

- Keep chain shields, flexible or solid deflector shields or discharge chutes in place and in good repair.
- Keep everyone several hundred (300) feet from mowing operation.
- Never direct mower discharge toward anyone.
- Keep hands, feet and other body parts away from rotating parts, blades and discharge openings.
- Do not operate mower in transport position.

Mower PTO drive engagement:

- Raise mower to maximum cutting height.
- Engage PTO at low engine rpm.
- Increase engine rpm to mower rated rpm PTO speed.
- Lower mower to desired cutting height.
- Stop and shut down immediately if the mower strikes an obstruction.
- Inspect and repair any mower damage before resuming mowing.
- Do not operate mower with severe vibrations or with unusual noise.

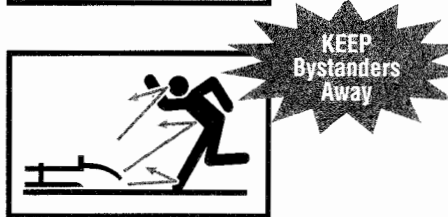
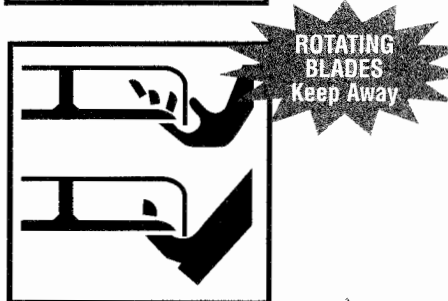
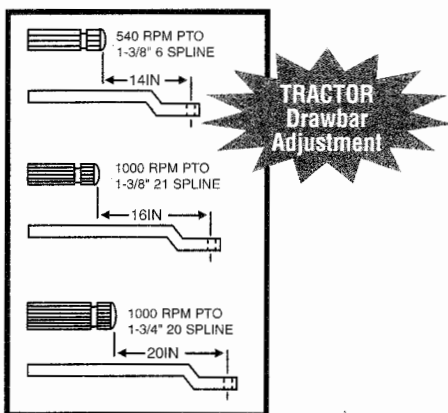
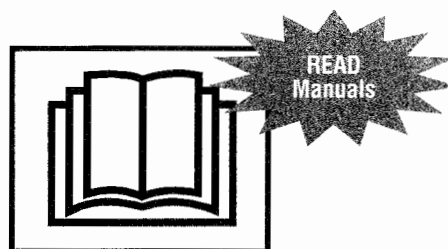

LOOK OUT
For Others

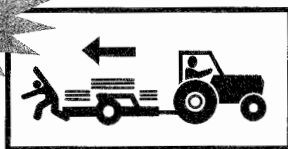

Mowing In Reverse Safety

Avoid mowing in reverse direction when possible.

Do the following when mowing in reverse direction:

- Check for any persons behind mower before reversing direction.
- Use extreme care when reverse direction mowing.
- Maintain rotary mower front and rear safety shields and flail front shields and rear rollers.

MAINTAIN
FLAIL
Rear Roller

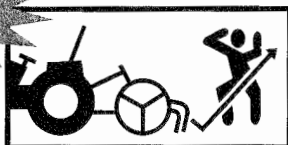

Mowing Ground Speed

Proper ground speed depends on terrain conditions and grass type, density and height to be cut:

- Normal ground speed range is 2 to 5 mph.
- Slower ground speed for mowing tall, dense grass.
- Faster ground speed for mowing medium height, thin grass and under smooth terrain conditions.
- Use slower ground speed for mowing in rough, sloping or unfamiliar terrain.

USE PROPER
Ground Speeds

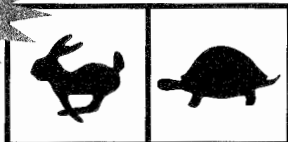

STOP BLADE
Before
Unclogging



Extremely tall grass mowing

- You may need to mow extremely tall grass twice.

First mowing pass:

- Cut grass higher (10-15 inches) to avoid hidden objects.

Second mowing pass:

- Remove debris and objects.
- Cut grass at desired height and 90 degree to the first mowing pass when possible.
- Use proper equipment shutdown practice for your safety before dismounting tractor.

PROVIDE
Adequate
Clearance for
Mower Swing

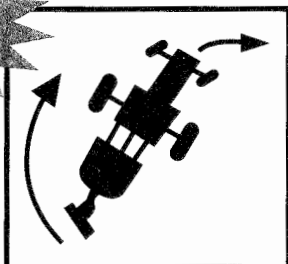

Watch equipment clearances

Three-point hitch and side mounted mowers have a larger turning arc than pull-type mowers. Allow sufficient clearance for safe turning.

NEVER STAND
On Mower
Keep Away

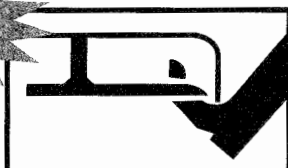

Under Mount Mower Safety

When mowing with an under mount mower:

- Keep removable discharge chute in place and over discharge opening.
- Never stand on an operating mower housing.
- Distribute grass clipping with discharge chute facing mowed area.
- Use proper equipment shutdown practice before clearing clogged mower or discharge chute.

KEEP CHUTE
In Place

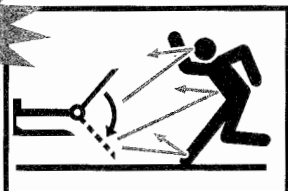

Wing Or Boom Type Mower Overhead Obstruction Hazards and Risks

Check for overhead obstructions with raised wings or boom-type mowers to avoid serious injury or death by contact with:

- Electrical power lines.
- Low tree limbs.
- Other overhead obstructions.

Wing And Side Mount Mowers Safety

When mowing with wing and side-mount mowers:

Raised wing positions reduces shielding protection and increases the thrown object and blade contact hazard risks.

To avoid serious injury or death by thrown objects or blade contact from raising and lowering wings during mowing operations:

- Do not mow with bystanders in mowing area.
- Be sure no one is near mower while raising or lowering wings.
- Keep the exposed rotating wing blade time to a practical minimum during a raised wing mowing operations.
- Stop mowing if persons enter into mowing area.
- Only raise wing to clear objects in the mowing path or to match ground slope.
- Disengage wing drive for extended periods of mowing with raised wings.
- Lower raised wing to ground after clearing object or ground slope conditions.
- Allow all mower blades to stop rotating before raising wing sections during other operations.

Ditch Bank Mowing Safety

Use extreme care when mowing ditch banks. Watch for washouts, eroded areas and mowing obstructions along the ditch banks. Hitting obstructions with side-mount or boom mowers may swerve the tractor's front end toward the ditch.

Raised wing and boom-type mower ditch bank operations may reduce the mower's thrown object shielding effectiveness for the mower operator's protection.

To increase operator protection from thrown objects during ditch bank operations:

- Use enclosed ROPS cabs, special protective enclosures and other operator shielding when performing these operations.
- Inspect mowing area and remove or mark all foreign objects and debris to be avoided by mower.



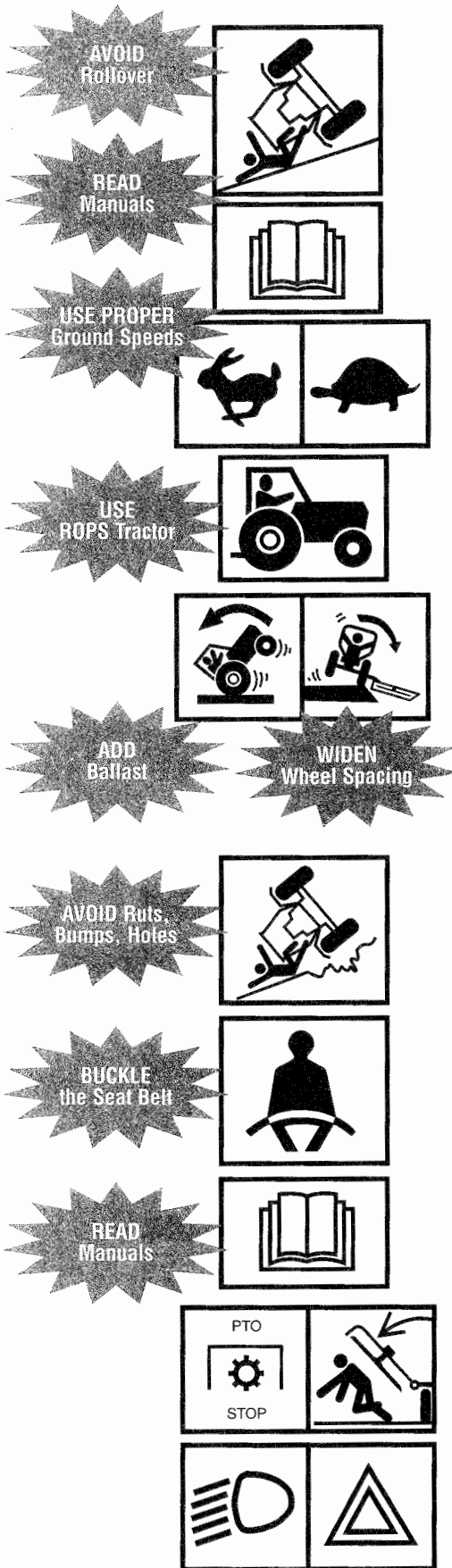

Mowing Uneven Terrain Safely

The tractor and mower stability is reduced on slopes and uneven terrain.

You can prevent tractor and mower overturns and maintain equipment stability control by:

- Reviewing tractor and mower operator's manuals for operating safety practices on slopes and uneven terrain conditions. Explain the practices to those users and operators who cannot read.
- Avoiding extremely steep slope operations.
- Using extreme care to maintain control over your equipment when operating in these conditions.
- Increasing tractor stability by adding wheel weights and increasing wheel spacing (Refer to tractor operator's manual for recommendations)
- Using ROPS and seat-belt-equipped tractor for operator safety during mowing operations.
- Maintaining minimum ground speed.
- Making wide and gradual turns.
- Avoiding sudden starts, stops, and turns when operating up, down, or across slopes.
- Not raising rear-mount or side-mount mowers or mower wings from the ground during these operations .
- Keeping alert for holes, bumps, ruts, rocks, stumps or other obstructions that could overturn tractor and mower.
- Avoiding slippery ground conditions that could overturn tractor and mower.
- Avoiding tractor and mower "hang up" by diagonal passing through sharp dips and drops.

Use extreme care in maintaining equipment stability during all uneven terrain and slope mowing operations. You are the final judge as to any slope that can be safely negotiated.

Equipment Road Transporting Safety

If equipment is to be driven on public roads:

- Refer to tractor and mower manufacturers' operator's manuals for instructions.
- Explain the instructions to those users or operators who cannot read.
- Check local regulations for required equipment markings, lights, flashers, etc., while traveling on public roads. Lights are required on mowers that obscure tractor taillights and/or warning lights.

Before transporting on public roads:

- Disengage PTO to mower.
- Raise mower into transport position.
- Lock wings up into transport position with locking devices on wing-type and side-mounted mowers.
- Attach safety chain between pull-type mower and tractor.
- Make sure lights, flashers, reflectors and SMV are in place and visible.
- Check SMV (Slow-Moving Vehicle) emblem for visibility to any rear approaching vehicle.

While transporting on public roads:

- Obey all local traffic regulations.
- Approach intersections with caution.
- Observe speed and traffic control signs.
- Avoid panic stops and sharp turns.

Parking Safety

Park equipment at:

- Designated or out-of-traffic areas.
- Preferably level ground locations.

Sloping ground parking locations:

- Position equipment across slope.
- Set parking brakes.
- Lower mower to ground.
- Block tractor wheels.

Before temporarily parking and leaving disabled equipment near traffic areas:

- Remove equipment from public roads.
- Set out warning flags
- Use tractor flashers.

Safety – During Shutdown

Use Proper Equipment Shutdown Practices For Your Safety

Refer to tractor and mower manufacturer’s operator manual(s) for recommend shutdown procedures. Explain the procedures to those users or operators who cannot read.

Make proper equipment shutdown procedures an important habit to practice. Follow these safety practices before dismanting tractor:

- Disengage PTO clutch and transmission drive.
- Idle engine for gradual cooling.
- Place the controls in PARK or NEUTRAL.
- Set the parking brake.
- Lower mower to ground.
- Lower wings of wing-type mowers to ground.
- Shut off engine.
- Wait for all moving parts to stop before equipment inspections, adjustments or repairs.
- Relieve hydraulic pressure by moving hydraulic controls several times in all directions.
- Lock ignition and remove key when equipment is to be inspected, repaired, adjusted or unattended.
- Lock anti-vandalism covers and closures when equipment is unattended.
- Dismount carefully maintaining three-point contact.

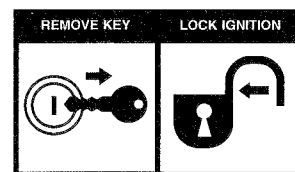
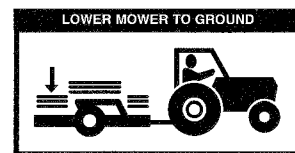
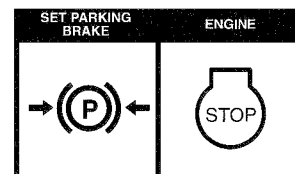
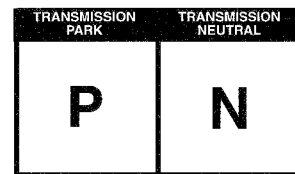
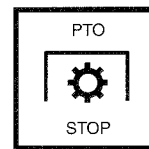
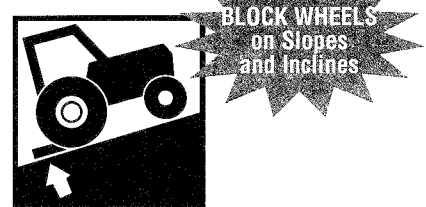
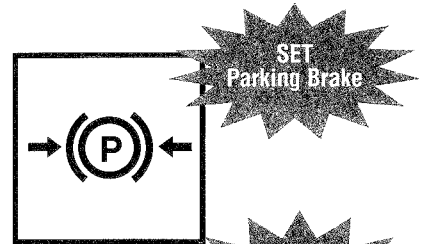
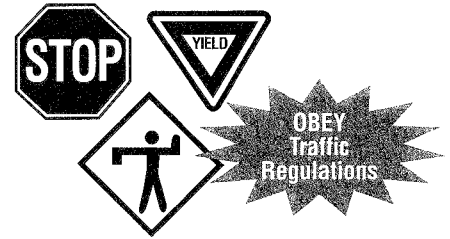

WAIT For Moving Parts to Stop Before Dismount



USE Three Point Contact



MAINTAIN Equipment

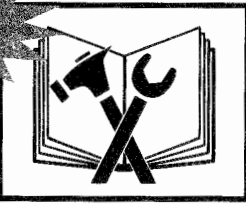

FOLLOW

Maintenance Schedule



Dismounting Tractor Safely

Before dismounting tractor:

- Use proper equipment shutdown practice for your safety.
- Lower implement to the ground, stop engine and PTO, set brakes, allow all moving parts to stop, and remove key before dismounting from tractor.
- Never dismount from moving equipment.
- Never jump from machines.
- Dismount carefully.
- Check for slippery steps
- Keep feet and hands away from controls.
- Use handholds and steps during dismount.
- Face machine and use 3 point contact (2 hands, 1 foot or 2 feet, 1 hand).

Safety – During Maintenance

Maintenance Safety

Do the following for your safety before performing any maintenance, repairs or service procedures:

- Follow proper equipment shutdown practice.
- Wear all the protective clothing and personal safety devices necessary to safely perform the job.
- Refer to your manufacturer's manuals for proper maintenance, repair and service procedures. Explain the procedures to those users and operators who cannot read.

Stored energy sources (electrical, mechanical, hydraulic, pneumatic, chemical, thermal, etc..) must be either locked, blocked, relieved, disconnected, stopped, secured, neutralized, controlled or reduced to a practical minimum before any maintenance, repair or service procedures can be done safely.

Some basic safety practices to prevent potential injuries from energy releasing sources:

- Disengage PTO before shutting off engine.
- Place controls in PARK or NEUTRAL before shutting off engine.
- Set parking brake or block wheels.
- Allow all moving parts to stop.
- Lower mower to ground.
- Lower wings to ground on wing-type mowers.
- Shut off tractor engine.
- Lock ignition and remove key.
- Look and listen for evidence of moving parts before opening shields.
- Securely support or block-up mower before working underneath mower or other lifted components.
- Securely support, block-up, or lock-up mower wings with locking devices before working near or underneath a wing-type mower.
- Relieve hydraulic system pressure by moving controls several times in all directions.
- Relieve pressure before disconnecting or disassembling any pressurized system.
- Block or relieve spring pressure before disassembling any spring-loaded mechanism.
- Securely support or block up any elevated machine component before working on it.
- Avoid flames, sparks, or smoking near any fuels.

Mower Manufacturer Parts and Your Safety

Most mower manufacturers use special fasteners and specially designed parts to meet mowing operations requirements.

Critical safety-related parts (Self-locking blade bolts, blades, pins, shields or other special items) have specific strength, design and fit requirements for the make and model mower you are using.

Modifications or repair parts not approved by the mower manufacturer can cause serious safety hazard exposure risk to you and others.

TO AVOID SERIOUS INJURY OR DEATH FROM UNAPPROVED PARTS OR MODIFICATIONS:

- Do not substitute common hardware for self-locking blade bolts or other special part items.
- Do not substitute blades, pins, shields or other critical safety-related parts.
- Do not use grade 5 or 8 bolts to replace grade 2 shear bolts.

FOLLOW THE SAFETY PRACTICE OF ALWAYS CHECKING THE MOWER FOR PROPER FUNCTION AFTER ALL ADJUSTMENTS REPAIRS OR SERVICE.

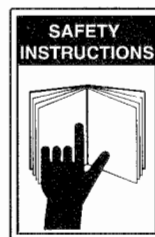
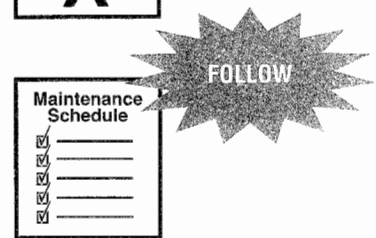
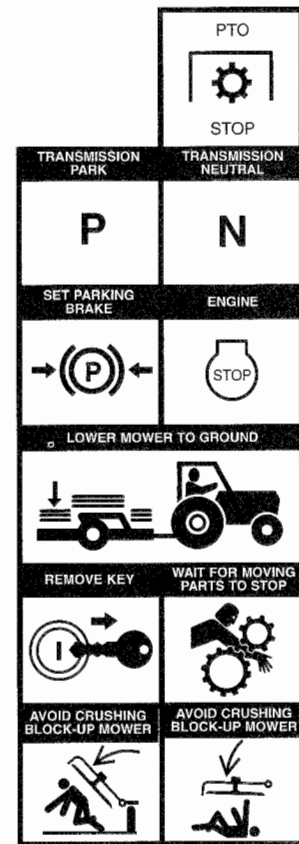

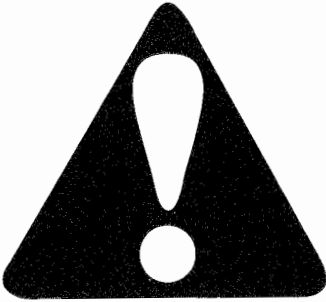

One Final Word



You have just finished reading the Mower Safety Manual. It is impossible for this manual to cover every potentially hazardous situation you may encounter. But, your knowledge of these safety precautions and your adherence to the basic rules of safety will help build good judgment in all situations. Our objective is to help you develop good safety habits and make you a better mower operator. The mower safety manual, safety precautions and basic rules of safety must be explained to those users or operators who cannot read.

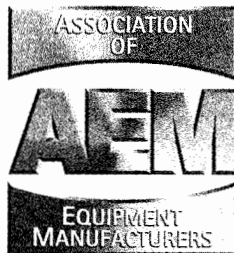

111 E. Wisconsin Avenue • Milwaukee, Wisconsin 53202 U.S.A.
www.aem.org

For information on additional copies of this and
other safety manuals, call 800-369-2310



Segadora industrial y agrícola

manual de seguridad

*para operadores
y mecánicos*

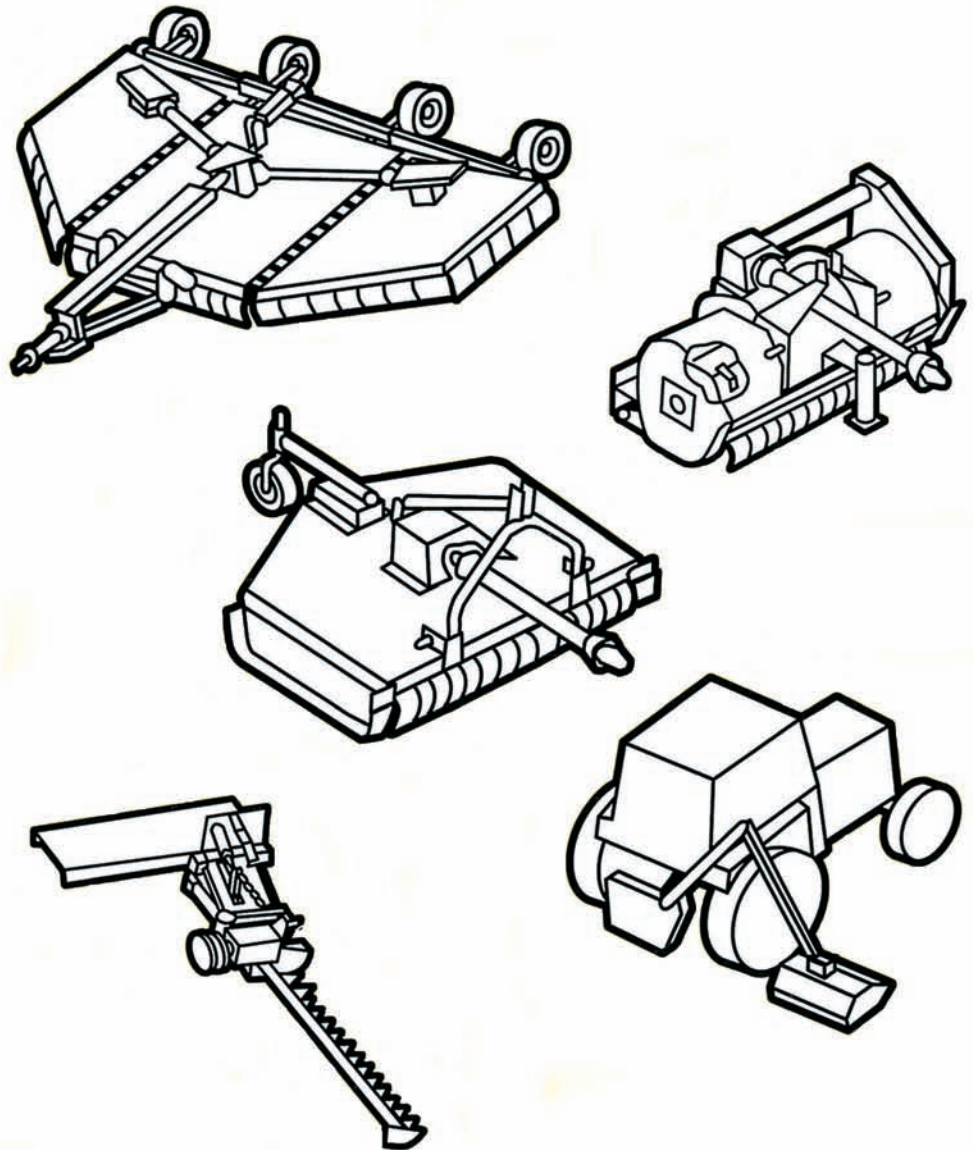

111 E. Wisconsin Avenue • Milwaukee, Wisconsin 53202 U.S.A.
www.aem.org

Contenido

Reconocimiento	2
Introducción	3
Palabras para el usuario	3
Alerta de seguridad	4
Segadoras industriales y agrícolas	4
Sea un operador responsable	5
Manejo seguro de riesgos y peligros	6
Cumpla con un programa de seguridad	11
Seguridad previa a la operación	11
Seguridad durante el arranque y prueba	13
Seguridad durante la operación	14
Seguridad durante la parada	18
Seguridad durante el mantenimiento	19
Palabra final	21

Reconocimiento

Deseamos extender nuestro reconocimiento a los miembros de del Association of Equipment Manufacturers por sus contribuciones para la preparación de este manual de seguridad.

Derechos de autor

© 2000 Equipment Manufacturers Institute. Todos los derechos reservados. Revisado 08.2003

Introducción

El propósito de este manual de seguridad es señalar algunas de las situaciones básicas de seguridad que pueden ocurrir durante la operación y mantenimiento de su máquina y sugerir los métodos posibles para tratar estas situaciones. Este manual NO es un sustituto de el (los) manual(es) del fabricante.

Pueden ser necesarias algunas precauciones adicionales, o algunas instrucciones no pueden aplicar, dependiendo del equipo, dispositivos de fijación, y las condiciones del lugar de trabajo o del área en que se realiza el servicio. El fabricante no tiene control directo sobre las aplicaciones, operación, inspección, lubricación o mantenimiento de la máquina. Por lo tanto, es **SU** responsabilidad practicar buenas medidas de seguridad en estas áreas.

La información proporcionada en este manual sirve como complemento de los detalles de información específicos de su máquina que están incluidos en el (los) manual(es) del fabricante. La información adicional que pueda afectar la operación segura de su máquina puede estar incluida en las etiquetas de seguridad o en los requisitos del seguro, programas de seguridad del empleador, códigos de seguridad, leyes locales del estado/provincia y leyes nacionales, reglas y reglamentos.

IMPORTANTE: si usted no tiene el (los) manual(es) del fabricante de su máquina específica, obtenga un manual de reemplazo con su empleador, distribuidor de equipo o el fabricante de su máquina. Mantenga este manual de seguridad y el (los) manual(es) del fabricante con su máquina.

Palabras para el usuario

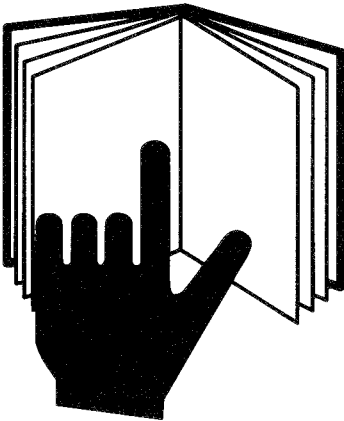

Usted tiene la responsabilidad de leer y comprender este manual de seguridad y el (los) manual(es) del fabricante, antes de operar esta máquina. Este manual de seguridad lo guía paso a paso a lo largo de su día de trabajo. El manual de seguridad, el (los) manual(es) del fabricante, avisos de seguridad (calcomanías) y precauciones de seguridad, deben explicarse a los usuarios u operadores que no puedan leer el material.

Adicionalmente al diseño y configuración del equipo el **CONTROL DEL PELIGRO** y la **PREVENCIÓN DE ACCIDENTES** dependen de la conciencia, preocupación, prudencia y capacitación adecuada de los propietarios y operadores durante la operación, transporte, mantenimiento y almacenamiento del equipo.

Recuerde que **USTED** es la clave para mantener la seguridad. Las buenas prácticas de seguridad no lo protegen solamente a usted sino que también a las personas que lo rodean. Estudie este manual y el (los) manual(es) del fabricante para su máquina específica. Hágalos una parte integral de su programa de seguridad. Recuerde que este manual de seguridad está escrito únicamente para segadoras industriales y agrícolas.

Practique todas las precauciones de seguridad usuales y acostumbradas en el trabajo y más que todo – recuerde que la seguridad depende de USTED. Solamente USTED puede evitar las lesiones graves o la muerte debidas a prácticas inseguras.

Advertencia de seguridad

Símbolo

Este símbolo de alerta de seguridad significa:

“¡ATENCIÓN! ¡MANTÉNGASE ALERTA! ¡SU SEGURIDAD ESTÁ INVOLUCRADA!”



El símbolo de alerta de seguridad identifica los mensajes de seguridad importantes en el equipo, en los avisos de seguridad, en los manuales y en otros lugares. Cuando usted vea este símbolo, esté alerta a la posibilidad de muerte o lesiones. Siga las instrucciones en el aviso de seguridad.

Palabras de señales

Las palabras de señales son palabras específicas que regularmente se encontrarán en las calcomanías de seguridad en este equipo o en otros equipos en el lugar de trabajo. Estas palabras tienen el objetivo de alertar a la persona que las vea de la presencia y el grado relativo de un riesgo.



Esta palabra de señal indica una situación de riesgo inminente que si no es evitado podrá resultar en la muerte o lesiones graves.



Esta palabra de señal indica una situación potencialmente riesgosa que si no se evita podría resultar en la muerte o lesiones graves.



Esta palabra de señal indica una situación potencialmente riesgosa que si no se evita podría resultar en lesiones menores o moderadas.

- LOS ACCIDENTES PUEDEN LISIAR Y CAUSAR LA MUERTE.
- LOS ACCIDENTES SON COSTOSOS.
- LOS ACCIDENTES PUEDEN EVITARSE.

Segadoras industriales y agrícolas

Es una segadora para cortar pasto, triturar residuos de cultivos, cortar maleza para la limpieza de terrenos, vías navegables, derechos de paso, cortes en los bordes de los caminos o carreteras.

TIPOS DE SEGADORAS INDUSTRIALES Y AGRÍCOLAS:

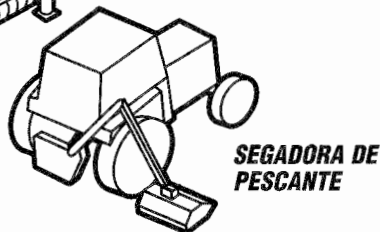
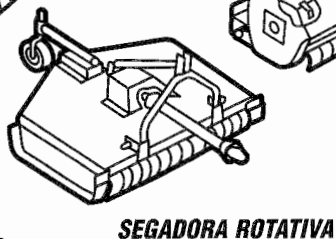
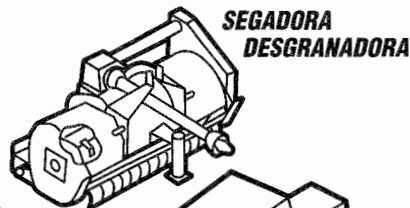
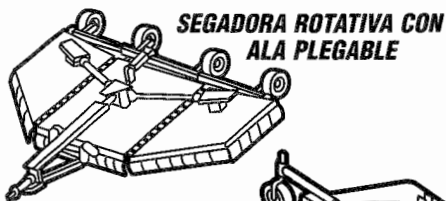

Sea un operador responsable



Para la operación segura de su equipo usted debe ser un operador responsable. Un operador responsable debe comprender claramente las instrucciones escritas proporcionadas por el fabricante ser capacitado – incluyendo la operación real del equipo y el conocimiento de las reglas y reglamentos de seguridad del lugar de trabajo.

Las medicinas y el alcohol pueden y afectarán el estado de alerta y coordinación del operador, por lo tanto, afectarán la habilidad del operador para operar el equipo en forma segura. Un operador **NUNCA** debe usar medicinas que puedan afectar su estado de alerta, juicio y coordinación; ni beber alcohol mientras opera equipo motorizado incluyendo tractores y segadoras. Un operador que use medicamentos por prescripción médica o de venta libre debe consultar con un médico profesional para conocer sobre cualquier efecto secundario que podría limitar su habilidad para operar este equipo en forma segura. **NUNCA** permita que alguien opere este equipo cuando estén afectados su estado de juicio alerta o de coordinación.

Protéjase usted mismo

Use toda la ropa protectora y los dispositivos de seguridad personal que se le proporcionen o que sean los indicados para las condiciones de trabajo.

Usted puede necesitar:

- Casco protector
- Zapatos de seguridad
- Anteojos de seguridad con protección lateral, gafas protectoras o protector facial
- Guantes extrafuertes
- Protección auditiva
- Ropa reflectora
- Equipo para clima húmedo
- Respirador o máscara filtrante

Use ropa apropiada para las condiciones del trabajo.

Siempre conozca cómo obtener ayuda en caso de una emergencia. Conozca donde encontrar y cómo usar los equipos de primeros auxilios y el extintor de incendios/sistema de supresión de incendios.



**Manténgase alerta. Evite los accidentes.
No conozca la seguridad en la forma más difícil.**

Manejo seguro de riesgos y peligros

Adicionalmente al diseño y configuración del equipo, el **CONTROL DEL PELIGRO** y la **PREVENCIÓN DE ACCIDENTES** dependen de la conciencia, preocupación, prudencia y capacitación adecuada de los propietarios y operadores durante la operación, transporte, mantenimiento y almacenamiento del equipo.

EL MANEJO SEGURO DE RIESGOS Y PELIGROS ES UN ELEMENTO ESENCIAL PARA LOS PROPIETARIOS Y OPERADORES RESPONSABLES DE TRACTORES Y SEGADORAS.

REVISE EL MANEJO SEGURO DE LOS PELIGROS Y RIESGOS ENUMERADOS A CONTINUACIÓN.

Peligro de objetos despididos

EXISTE LA POSIBILIDAD DEL RIESGO DE LESIONES A LOS OPERADORES Y TRANSEÚNTES CAUSADAS POR OBJETOS DESPIDIDOS DURANTE LA OPERACIÓN DE LA SEGADORA POR LOS SIGUIENTES:

OBJETOS (PIEDRAS, ESCOMBROS, HOJAS ROTAS DE LA SEGADORA, PERNOS DE LA HOJA, CABLES, CADENAS, ALAMBRE, ETC.) DESPIDIDOS POR LA SEGADORA.

Dispositivos protectores del equipo y prácticas de seguridad recomendadas

La cubierta de la segadora y los dispositivos protectores no pueden evitar que escapen todos los objetos o desechos del área cerrada de la hoja en todas las condiciones de segado. Es posible que los objetos escapen y se desplacen cientos de pies (300 [100 m]).

PRÁCTICAS DE SEGURIDAD RECOMENDADAS

Lea los manuales del operador del fabricante para conocer las prácticas de seguridad recomendadas durante la operación. Explique las prácticas a los usuarios u operadores que no puedan leer.

PARA AYUDAR A EVITAR LESIONES GRAVES O LA MUERTE CAUSADAS POR OBJETOS QUE GOLPEEN AL OPERADOR U OTRAS PERSONAS HAGA LO SIGUIENTE:

SEGURIDAD DE TRANSEÚNTES

- Mantenga a los transeúntes a varios cientos de pies (300 [100 m]) del área segada.

SEGURIDAD PROPORCIONADA POR LOS DISPOSITIVOS PROTECTORES DEL EQUIPO

Para contener, desviar o reducir los objetos despididos del área cerrada de la hoja:

- Mantenga la cadena, blindajes deflectores flexibles o sólidos colocados en la parte delantera y trasera de la cubierta de la segadora, en su lugar y en buen estado de funcionamiento.
- No opere el equipo con los blindajes para objetos despididos dañados o sin que estén colocados en su lugar.



SEGURIDAD DEL OPERADOR

La operación de las segadoras con las alas levantadas, de montaje lateral y pescante, pueden reducir la efectividad del blindaje para proteger al operador contra los objetos despedidos de la segadora.

Haga lo indicado a continuación para aumentar la protección del operador contra los objetos despedidos durante las operaciones de segado:

- Use cabinas cerradas con una estructura de protección contra vuelcos (ROPS), cubiertas protectoras especiales, mallas u otros dispositivos para proteger al operador cuando efectúa estas operaciones.

SOBREPASAR LAS VELOCIDADES RECOMENDADAS PARA LA TOMA DE FUERZA (PTO)

No sobrepase las velocidades recomendadas por el fabricante para la toma de fuerza (PTO).

Las velocidades excesivas de la toma de fuerza (PTO) pueden causar:

- Fallo de la hoja
- Escape de objetos a velocidad alta u hojas rotas despedidas del área cerrada de la hoja de la segadora.
- Fallos potenciales de la línea de transmisión de 540 rpm cuando se opera a velocidades de 750 a 1000 rpm.

OTRAS PRÁCTICAS DE SEGURIDAD:

- Nunca debe operar la segadora con hojas rotas, dobladas, faltantes o que estén extremadamente desgastadas.
- Antes de segar retire los desechos y objetos extraños para evitar que sean recogidos y despedidos por la segadora.
- No debe operar la segadora durante el transporte o en posición de ala levantada.

PRÁCTICAS DE MANTENIMIENTO RECOMENDADAS

Lea los manuales del operador del fabricante para conocer sobre la inspección y mantenimiento de las defensas de la cadena y blindaje deflector flexible o sólido:

- Reemplace las defensas desgastadas o dañadas y los demás blindajes antes de segar.
- Use solamente las defensas y blindajes de reemplazo del fabricante. Otras defensas o blindajes pueden no encajar, o los materiales pueden no ser adecuados para cumplir con los requisitos de resistencia del equipo.
- Reemplace las calcomanías desgastadas o dañadas y las instrucciones de advertencia.
- Explique las instrucciones de inspección y mantenimiento a los usuarios u operadores que no puedan leer.

USE cabinas cerradas con una estructura protectora contra vuelcos (ROPS) o cubiertas protectoras

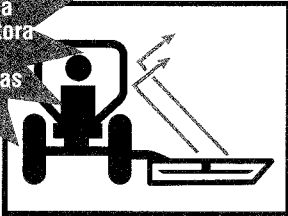

USE la velocidad apropiada de la toma de fuerza (PTO)

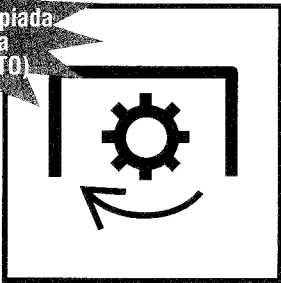

DÉ MANTENIMIENTO a su equipo

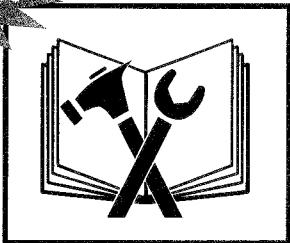

Peligros y riesgos de las hojas rotativas y línea de transmisión

EXISTE EL RIESGO DE POSIBLES LESIONES A LOS OPERADORES DE LA SEGADORA Y TRANSEÚNTES DURANTE LAS OPERACIONES DE SEGADO CAUSADAS POR LO SIGUIENTE:

- CONTACTO DEL CUERPO CON LAS HOJAS ROTATIVAS.
- ENREDO DEL CUERPO CON LAS LÍNEAS DE TRANSMISIÓN Y PIEZAS ROTATIVAS.

Dispositivos protectores del equipo y prácticas de seguridad recomendadas

PRÁCTICAS DE SEGURIDAD RECOMENDADAS

Lea los manuales del operador del fabricante para conocer las prácticas de seguridad recomendadas. Explique las prácticas a los usuarios u operadores que no puedan leer. Para evitar el riesgo de lesiones graves o la muerte causadas por el contacto con la hoja en movimiento, línea de transmisión o enredo de los operadores u otras personas haga lo siguiente:

SEGURIDAD DE TRANSEÚNTES

- No debe operar cerca de transeúntes.
- Mantenga a otras personas a varios cientos de pies (300 [100 m]) del área de segado.

PRÁCTICAS DE SEGURIDAD DEL OPERADOR

- No permita pasajeros en el tractor o segadora. Asegúrese el cinturón de seguridad durante el segado.
- Use la práctica de parada del equipo apropiada antes de dar servicio, ajustar, limpiar o eliminar las obstrucciones de la segadora.
- Manténgase alejado de las hojas rotativas, piezas y líneas de transmisión.
- Nunca arranque el motor del tractor mientras esté de pie al lado del equipo.
- Solamente arranque el motor del tractor cuando esté sentado en el asiento del operador con el cinturón de seguridad abrochado.

PRÁCTICAS DE SEGURIDAD RECOMENDADAS PARA DEFENSAS Y BLINDAJES DE LA LÍNEA DE TRANSMISIÓN

- Mantenga las líneas de transmisión y otros blindajes colocados y en buen estado.
- No debe operar la segadora cuando las defensas, defensas de la línea de transmisión u otros blindajes hagan falta o estén dañados.

PRÁCTICAS DE SEGURIDAD RECOMENDADAS

Lea los manuales del operador del fabricante para conocer las instrucciones sobre defensas, defensas de la línea de transmisión y otros blindajes:

- Reemplace las defensas, defensas de la línea de transmisión y otros blindajes desgastados o dañados antes de segar.
- Use solamente defensas y blindajes de reemplazo hechas por el fabricante. Otras defensas o blindajes pueden no encajar o ser de materiales inadecuados que no cumplan con los requisitos de resistencia del equipo.
- Reemplace las calcomanías e instrucciones de advertencia desgastadas o dañadas.
- Explique las instrucciones de inspección y mantenimiento a los usuarios u operadores que no puedan leer.



EVITE enredarse

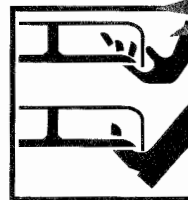

EVITE las piezas rotativas



LEA los manuales



ASEGÚRESE el cinturón de seguridad



NO LLEVE PASAJEROS



EVITE el ser atropellado



DÉ MANTENIMIENTO a su equipo

EVITE vuelcos

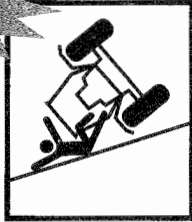

USE la estructura contra vuelcos (ROPS) del tractor



LEA los manuales

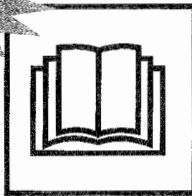

AGREGUE balasto



AUMENTE el espacio entre las ruedas y AGREGUE balasto en el lado contrario



ASEGURESE el cinturón de seguridad



EVITE EL APLASTAMIENTO asegure el ala



Peligros y riesgos de rodamiento o vuelco del tractor y segadora

EXISTE UN RIESGO DE LESIONES POSIBLES AL OPERADOR POR RODAMIENTO O VUELCO DE LA SEGADORA DURANTE LAS OPERACIONES DE SEGADO POR LO SIGUIENTE:

- TERRENO ACCIDENTADO, PENDIENTES INCLINADAS, AGUJEROS, BACHES, SURCOS, PIEDRAS, TRONCOS U OTRAS OBSTRUCCIONES QUE PODRÍAN VOLCAR EL TRACTOR Y SEGADORA.
- VELOCIDADES ABSOLUTAS EXCESIVAS PARA ESTAS CONDICIONES DE TERRENO.

Dispositivos protectores del equipo y prácticas de seguridad recomendadas

Cuando sea posible, retire los troncos, piedras, etc., o márquelos claramente con las demás obstrucciones para evitar vuelcos, averías y condiciones de conducción peligrosas. Tenga extremo cuidado para mantener el control sobre el equipo cuando opere en terrenos con estas condiciones.

ESTRUCTURAS CONTRA VUELCO (ROPS) RECOMENDADAS PARA TRACTORES

Un tractor equipado con una estructura contra vuelcos (ROPS) o cabina ROPS cerrada y cinturón de seguridad para la seguridad del operador, es esencial para la protección adicional del operador, cuando opera en terrenos con estas condiciones

AJUSTES RECOMENDADOS PARA LA ESTABILIDAD DEL TRACTOR

Lea el manual del operador del tractor para conocer los ajustes para aumentar la estabilidad del tractor:

- Agregue pesas o balasto a las ruedas delanteras y traseras.
- Ajuste el espacio entre las ruedas al ancho máximo.
- Agregue contra balasto en el lado contrario a las segadoras de montaje lateral y de pescante.
- Explique los ajustes a los usuarios u operadores que no puedan leer.

PRÁCTICAS DE SEGURIDAD RECOMENDADAS

Lea los manuales del operador del fabricante para conocer las prácticas de seguridad de operación recomendadas. Explique las prácticas a los usuarios u operadores que no puedan leer. **Para evitar lesiones graves o la muerte del operador por el vuelco del tractor y segadora, haga lo siguiente:**

- Abroche firmemente el cinturón de seguridad cuando seque con tractores equipados con una estructura contra vuelcos (ROPS).
- Evite la velocidad absoluta excesiva de acuerdo con las condiciones del terreno.
- Evite los arranques, paradas y virajes repentinos cuando opere subiendo, bajando o atravesando pendientes.
- Evite las condiciones de terreno resbaloso.
- Haga virajes anchos y graduales.
- Planifique segar cuesta abajo en pendientes inclinadas para evitar los vuelcos.

Peligros y riesgos de aplastamiento por una segadora o piezas desprendidas

EXISTE EL RIESGO DE UNA LESIÓN POR APLASTAMIENTO PARA LOS OPERADORES Y OTRAS PERSONAS DURANTE LAS OPERACIONES DE SEGADO DEBIDO A LO SIGUIENTE:

- SEGADORA O EQUIPO DESPRENDIDO DEBIDO A FALLO DEL SISTEMA HIDRÁULICO.
- FALLO EN DAR SOPORTE, BLOQUEAR O ASEGURAR COMPLETAMENTE LA SEGADORA O PIEZAS DEL EQUIPO.

Dispositivos protectores del equipo y prácticas de seguridad recomendadas

Lea los manuales del operador del fabricante para conocer las prácticas de seguridad de operación recomendadas. Explique las prácticas a los usuarios u operadores que no puedan leer. **Para ayudar a evitar lesiones serias o la muerte de los operadores y otras personas causadas por la caída de la segadora o piezas de equipo, haga lo siguiente:**

PRÁCTICAS DE SEGURIDAD RECOMENDADAS

Antes de trabajar cerca o debajo de la segadora o piezas de equipo en posición levantada:

- Use la práctica de parada del equipo apropiada antes de dar servicio, ajustar, limpiar o eliminar las obstrucciones de la segadora.
- Soporte o coloque bloques firmemente debajo de la segadora o piezas de equipo.
- En las segadoras de tipo ala coloque bloques o asegure firmemente las alas con los seguros o baje al suelo la segadora o piezas del equipo.
- Use los seguros de transporte cuando transporte la segadora en caminos públicos.

Peligros y riesgos por la fuga de fluido hidráulico a presión alta

EXISTE UN RIESGO PARA LOS OPERADORES DE SEGADORAS Y OTRAS PERSONAS DE UNA POSIBLE INYECCIÓN DE FLUIDO A PRESIÓN ALTA O GANGRENA CAUSADA POR LA INYECCIÓN EN LA PIEL DE ACEITE HIDRÁULICO O DIESEL.

PARA EVITAR LA GANGRENA, EL FLUIDO INYECTADO DEBE SER ELIMINADO QUIRÚRGICAMENTE EN POCAS HORAS, POR UN MÉDICO FAMILIARIZADO CON ESTE TIPO DE LESIÓN.

PRÁCTICAS DE SEGURIDAD RECOMENDADAS

Lea los manuales del operador del fabricante para conocer las prácticas de seguridad recomendadas. Explique las prácticas a los usuarios u operadores que no puedan leer. Las fugas de fluido a presión alta por agujeros minúsculos pueden ser casi invisibles.

Para ayudar a evitar lesiones serias o la muerte haga lo siguiente:

- Busque las fugas con pedazos de cartón o madera.
- No use las manos para verificar la presencia de fugas.
- Descargue la presión del sistema antes de desconectar los conductos.
- Antes de aplicar presión al sistema:
 - Revise que los conductos, tuberías y mangueras no estén dañados.
 - Revise que las conexiones estén apretadas.
- Antes de operar los sistemas presurizados:
 - Descargue el aire del sistema.
 - Haga referencia al (los) manual(es) del operador del fabricante para obtener instrucciones.
 - Explique los procedimientos a los usuarios u operadores que no puedan leer.

Peligros y riesgos durante el llenado de combustible del tractor

Para evitar las lesiones serias o la muerte por incendio durante el llenado:

- Apague el motor y la ignición.
- Nunca llene el tanque de combustible cerca de llamas descubiertas.
- Nunca fume mientras llena combustible.
- Evite las chispas causadas por la electricidad estática poniendo a tierra la boquilla del combustible contra el cuello de llenado del tanque.
- Evite sobrellenar el tanque o derramar el combustible.
- Limpie inmediatamente el combustible derramado.
- Siempre vuelva a colocar la tapa del combustible.

Para evitar lesiones serias o la muerte causadas por las emanaciones del escape del motor:

- Ventile adecuadamente los espacios cerrados antes de arrancar el motor.



LEA los manuales



EVITE EL APLASTAMIENTO coloque bloques o soportes seguros en la segadora



FLUIDO A PRESIÓN ALTA puede inyectarse en el cuerpo



LEA los manuales

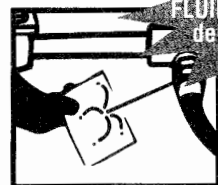

EVITE LA INYECCIÓN DE FLUIDO use un pedazo de cartón, no use las manos



EVITE los incendios y las explosiones

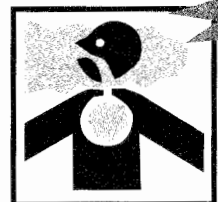

EVITE las emanaciones del escape

Cumpla con un programa de seguridad



LA SEGURIDAD ES IMPORTANTE PARA LOS PROPIETARIOS Y OPERADORES RESPONSABLES DE TRACTORES Y SEGADORAS. HAGA LO SIGUIENTE PARA SU SEGURIDAD DURANTE LA OPERACIÓN DE SEGADO:

SEA UN OPERADOR CAPACITADO HACIENDO LO SIGUIENTE:

- Leyendo, comprendiendo y obedeciendo las instrucciones escritas del fabricante en el (los) manual(es) del operador y avisos de seguridad en la segadora y tractor.
- Recibiendo capacitación operativa para la segadora y tractor.
- Solicitando a su distribuidor de equipo o supervisor que le explique lo que usted no comprende.
- Explicando las instrucciones escritas en el (los) manual(es) del operador y avisos de seguridad (calcomanías) en la segadora y tractor a los usuarios u operadores que no puedan leer.

Seguridad previa a la operación

Conozca las reglas y reglamentaciones de seguridad del lugar de trabajo

Pregunte a su supervisor sobre las reglas de seguridad de operación del equipo que usted deberá obedecer.

Algunas reglas para su seguridad y la de los demás:

- Un tractor equipado con una estructura contra vuelcos (ROPS) es necesario para la protección del operador durante las operaciones de segado.
- Conozca la capacidad y características de operación de la segadora y tractor.
- Nunca altere o desmonte el equipo de seguridad.
- Nunca permita que niños o personas no capacitadas operen una segadora o tractor.
- Nunca permita pasajeros en la segadora o tractor.
- Mantenga a otras personas alejadas de la operación de segado.
- Use la práctica apropiada para parar el equipo antes de bajarse del tractor.
- Permita que se detengan todas las piezas móviles antes de efectuar inspecciones, reparaciones o ajustes al equipo.
- Soporte o coloque bloques firmemente debajo de la segadora antes de trabajar debajo de la segadora o componentes elevados.
- Use la ropa protectora y dispositivos de seguridad personal que le han sido asignados o recomendados por el fabricante del equipo.



Conozca los controles del tractor y segadora

Conozca lo siguiente sobre su tractor y segadora:

- Función, propósito y uso de los controles.
- Velocidades seguras de operación.
- Capacidad para operar en forma segura en pendientes y terreno accidentado.
- Características de frenado y dirección.
- Espacios libres necesarios para la operación del tractor y segadora.
- Cómo detener rápidamente el equipo cuando haya una emergencia.



Use todos los dispositivos de seguridad del equipo disponibles

Para ayudar a mantener su seguridad y la de las personas que lo rodean:

- Asegúrese de que las defensas, blindajes y avisos de seguridad recomendados por el fabricante están instalados en el equipo y en buen estado.
- Mantenga todos los dispositivos protectores en su lugar y abrochados firmemente.
- **NUNCA** debe operar su equipo con los dispositivos de seguridad sin colocar, desconectados o dañados.
- Use el balasto y peso requerido para la estabilidad operativa del equipo.

Inspeccione el equipo de la segadora y tractor

Antes de comenzar su día de trabajo:

- Revise que no haya piezas del tractor y segadora que estén sueltas, rotas, dañadas o que no estén colocadas en su lugar.
- Repare o reemplace estas piezas cuando sea necesario.
- Verifique que los implementos del tractor y segadora sean los apropiados.
- Verifique que sean iguales las rpm de régimen de la toma de fuerza (PTO) a las del tractor y de la segadora.
- Revise el estado de las hojas de la segadora. Afile o reemplace de acuerdo con las recomendaciones del fabricante. Las modificaciones a las hojas como soldadura o endurecimiento de los bordes cortantes con soldadura o enderezado de las hojas dobladas, pueden reducir la resistencia de las hojas y afectar adversamente las propiedades y seguridad de las hojas.
- Verifique que todas las defensas y blindajes estén colocados en su lugar y que todo el equipo esté en buen estado de funcionamiento. Esto incluye la línea de transmisión de la toma de fuerza (PTO), caja de engranajes, defensas y blindajes del implemento que sirven para la protección del operador.
- Verifique que la horqueta de la línea de transmisión y los dispositivos de seguro estén correctamente asegurados.
- Verifique que los sistemas hidráulicos del tractor y segadora no estén dañados ni tengan fugas.
- Revise y lea los avisos de seguridad y las instrucciones de advertencia.
- Explique los avisos de seguridad e instrucciones de advertencia a los usuarios u operadores que no puedan leer.

Inspeccione el área de trabajo

Inspeccione, identifique y evite las condiciones peligrosas en el área de trabajo:

- Terreno accidentado, bajadas escarpadas, zanjas, agujeros, pendientes inclinadas, troncos, agua estancada, suelo de lodo suave, condiciones resbalosas, desechos y objetos extraños.
- Inspeccione el área de segado y elimine o marque todos los objetos extraños y desechos que debe evitar con la segadora.

Analice el área de segado para establecer:

- El mejor y más seguro procedimiento de segado.
- Tipo de material y altura de segado.
- Estado del terreno de operación.
- El uso de un patrón de segado de desplazamiento hacia delante siempre que sea posible.

Verifique la seguridad de las demás personas

Antes de arrancar el equipo:

- Camine alrededor del equipo.
- Verifique que no haya nadie debajo, sobre o cerca del equipo.
- Aleje a todas las personas de estas áreas.
- Haga sonar una alarma.



USE UNA ESTRUCTURA CONTRA VUELCOS (ROPS) y el cinturón de seguridad

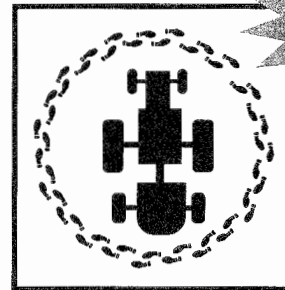

CAMINE ALREDEDOR para inspeccionar

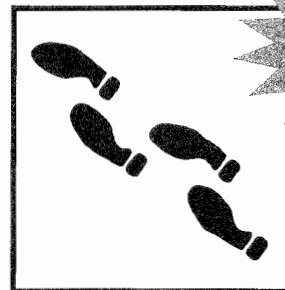

CAMINE ALREDEDOR del lugar de trabajo

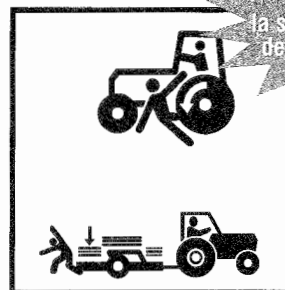

VERIFIQUE la seguridad de las demás personas

Seguridad durante el arranque y prueba

USE
el contacto de
tres puntos



USE UNA
ESTRUCTURA
CONTRA VUELCOS
(ROPS) y el
cinturón de
seguridad



USE la
velocidad
correcta de la
toma de fuerza
(PTO)

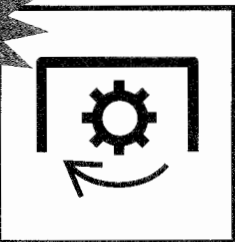

Seguridad durante la subida al tractor

Antes de subir:

- Límpiase los zapatos y las manos.

Durante la subida y la bajada del tractor:

- Use las asas y placas de los escalones.
- Nunca utilice los volantes de dirección o controles como asas.
- Nunca suba ni baje de un tractor en movimiento.

Prueba de seguridad de los controles del tractor y segadora

Antes del arranque:

- Ajuste y abroche el cinturón de seguridad en su tractor equipado con una estructura contra vuelcos (ROPS).
- Verifique que el freno de estacionamiento esté enganchado.
- Verifique que desenganche la toma de fuerza (PTO).
- Verifique que todos los controles estén en la posición de punto muerto (N) o de estacionamiento (P).
- Advierta a las demás personas presentes en el área antes de arrancar el tractor.
- Cumpla con los procedimientos de arranque recomendados por el fabricante del tractor.

Después del arranque:

- Revise que todos los instrumentos, indicadores y luces indicadoras funcionen normalmente.
- Revise que todos los controles, dirección y frenos del tractor funcionen apropiadamente.
- Repare un tractor que no esté funcionando apropiadamente antes de usarlo.
- Suba y baje la segadora cuando la línea de transmisión llegue al fondo o cuando existen problemas de enganche.
- Verifique que su equipo no vibre excesivamente y que no tenga ruidos anormales.
- Use prácticas apropiadas para detener el equipo antes de inspeccionarlo.

Seguridad en el sistema de toma de fuerza y segadora

Tractores con sistemas de doble velocidad (540 ó 1000 rpm) toma de fuerza (PTO) de cambios.

Para evitar las lesiones serias o la muerte por el fallo de piezas causado por la sobrevelocidad de la segadora:

- Asegúrese de colocar el selector de la toma de fuerza (PTO) a la velocidad de régimen de las rpm de la toma de fuerza (PTO).

Tractores con sistemas con toma de fuerza (PTO) impulsados por la transmisión.

Una segadora rotativa tendrá un efecto significativo de volante, que puede continuar impulsando el tractor cuando tiene un sistema de toma de fuerza (PTO) impulsado por la transmisión.

El tractor debe estar equipado y ser operado como se indica a continuación:

- Instale un embrague de sobremarcha.
- Permítase suficiente espacio y tiempo para maniobrar anticipando los virajes, paradas y reducciones de velocidad.

Seguridad durante la operación

Seguridad durante el enganche de la segadora al tractor

Seguridad en el montaje de la segadora con un enganche de tres puntos:

- Haga referencia a los manuales de los fabricantes de la segadoras y el tractor.
- Coloque la palanca selectora del elevador de potencia hidráulica del tractor (eje de balancín) en posición baja para evitar el movimiento inesperado.
- Explique los procedimientos de enganche a los usuarios u operadores que no puedan leer.

Seguridad en el montaje de la segadora con enganche de tipo tiro:

- Haga referencia a los manuales del fabricante de la segadora y tractor.
- Utilice solamente un enganche de barra de tiro.
- No la enganche al eje trasero del tractor ni a los brazos del enganche de tres puntos.
- Ajuste la longitud de la barra de tiro del tractor para la operación de la toma de fuerza (PTO) de 540 ó 1000 rpm.

Comience el uso de la segadora en forma correcta para mayor seguridad

Segue solamente durante el día o cuando exista iluminación artificial adecuada.

Para evitar las lesiones serias o la muerte causadas por objetos despedidos por la segadora o contacto con las hojas:

- Mantenga los blindajes de la cadena, blindajes deflectores flexibles o sólidos, conductos de descarga, colocados en su lugar y en buen estado.
- Mantenga a todas las personas a varios cientos de pies (300 [100 m]) de la operación de segado.
- Nunca dirija hacia ninguna persona la descarga de la segadora.
- Mantenga las manos, pies y otras partes del cuerpo alejadas de las piezas rotativas, hojas y agujeros de descarga.
- No debe operar la segadora en posición de transporte.

Enganche de la transmisión, toma de fuerza (PTO) de la segadora:

- Suba la segadora a la altura máxima de corte.
- Enganche la toma de fuerza (PTO) con rpm bajas del motor.
- Aumente las rpm del motor a la velocidad de régimen de las rpm de la toma de fuerza (PTO).
- Baje la segadora a la altura de corte deseado.
- Deténgase y pare inmediatamente si la segadora golpea una obstrucción.
- Inspeccione y repare cualquier daño que tenga la segadora antes de reiniciar el segado.
- No debe operar la segadora cuando tenga vibración excesiva o ruidos anormales.

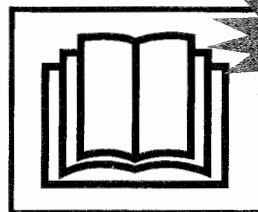

LEA los manuales

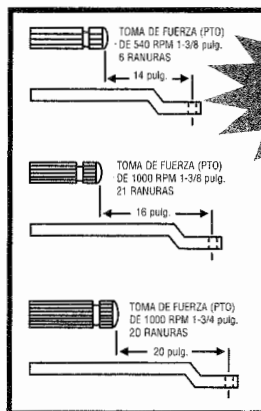

Ajuste de la barra de tiro del TRACTOR

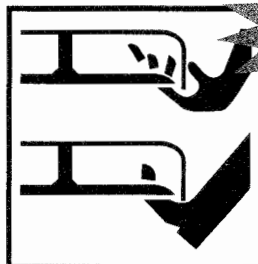

Mantenga la distancia de LAS HOJAS ROTATIVAS

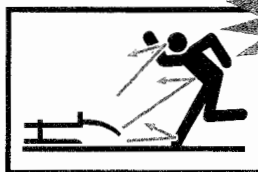

MANTENGA alejados a los transeúntes

CUIDE
que no haya
más personas

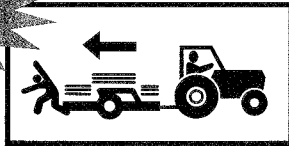

MANTENGA
el rodillo
trasero de la
desgranadora

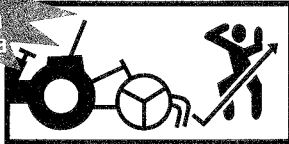

USE las
velocidades
absolutas
apropiadas

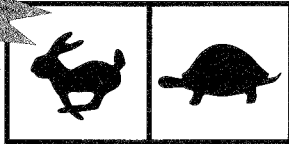

DETENGA
LA HOJA
antes de eliminar
obstrucciones



ESTABLEZCA
QUE el espacio
libre sea adecuado
para la oscilación
de la segadora

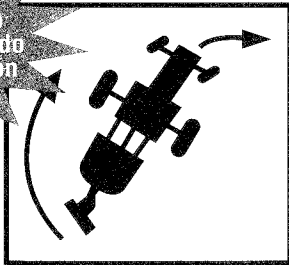

NUNCA
PERMANEZCA
DE PIE sobre
la defensa de
la segadora

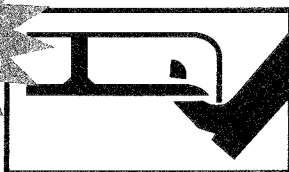

MANTENGA
EL CONDUCTO
colocado en
su lugar

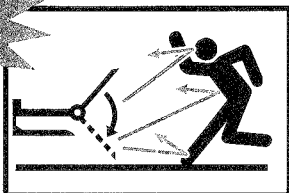

Seguridad durante el segado en marcha atrás

Evite segar en marcha atrás siempre que sea posible.

Haga lo siguiente cuando segue en marcha atrás:

- Verifique que no haya personas atrás de la segadora antes de dar marcha atrás.
- Use extremo cuidado al invertir la dirección del segado.
- Mantenga los blindajes de seguridad delanteros y traseros y los blindajes delanteros de la desgranadora y los rodillos traseros de la segadora rotativa.

Velocidad absoluta de segado

La velocidad absoluta depende de las condiciones del terreno, tipo de pasto, densidad y la altura de corte:

- El alcance normal de la velocidad absoluta es de 2 a 5 mph.
- La velocidad absoluta debe ser menor cuando segue pasto alto y denso.
- La velocidad absoluta puede ser mayor cuando segue pasto de altura mediana, delgado y cuando las condiciones del terreno sean uniformes.
- Use una velocidad absoluta menor cuando segue en pendientes accidentadas o terreno desconocido.

Segado de pasto extremadamente alto

- Puede ser necesario segar dos veces el pasto extremadamente alto.

Primera pasada de segado:

- Haga un corte alto al pasto (10-15 pulgadas [25-38 mm]) para evitar objetos escondidos.

Segunda pasada de segado:

- Retire los desechos y otros objetos.
- Corte el pasto a la altura deseada y a 90 grados de la primera pasada siempre que sea posible.
- Use las prácticas apropiadas de parada del equipo para su seguridad al bajar del tractor.

Vigile los espacios libres del equipo

Las segadoras con enganche de tres puntos y de montaje lateral tienen un arco de viraje mayor que las segadoras de tiro. Permita suficiente espacio libre para virar con seguridad.

Seguridad en el uso de las segadoras montadas en la parte inferior

Cuando segue con una segadora montada en la parte inferior:

- Mantenga el conducto de descarga desmontable colocado en su lugar sobre el agujero de descarga.
- Nunca permanezca de pie sobre la cubierta de una segadora que esté en operación.
- Distribuya el pasto cortado con el conducto de descarga hacia el área ya segada.
- Use las prácticas apropiadas para la parada del equipo antes de eliminar las obstrucciones de la segadora o conducto de descarga.

Riesgos y peligros de obstrucciones elevadas cuando se usan segadoras de ala o pescante

Verifique que no haya obstrucciones elevadas cuando use segadoras con alas levantadas o de tipo pescante, para evitar lesiones graves o la muerte causadas por el contacto con:

- Líneas de transmisión de energía eléctrica.
- Ramas bajas de árboles.
- Otras obstrucciones elevadas.

Seguridad en el uso de las segadoras de ala y de montaje lateral

Cuando utilice segadoras de ala y de montaje lateral:

Las posiciones con el ala levantada reducen la protección del blindaje y aumentan los riesgos de objetos despedidos y de contacto con la hoja.

Para evitar las lesiones serias o la muerte causadas por objetos despedidos o contacto con la hoja por la subida y bajada de las alas durante las operaciones de segado:

- No segue cuando haya transeúntes en el área de segado.
- Asegúrese de que no haya personas cerca cuando suba o baje las alas.
- Mantenga el período de tiempo durante el que está expuesta la hoja rotativa del ala, a un mínimo práctico durante las operaciones de segado con el ala levantada.
- Detenga el segado si entran personas en el área de segado.
- Solamente suba el ala para pasar sobre objetos que se encuentren en el camino de segado o para seguir la inclinación del terreno.
- Desenganche la transmisión del ala durante los períodos prolongados de segado con las alas levantadas.
- Después de pasar sobre un objeto o sobre inclinaciones del terreno, baje el ala levantada, al suelo.
- Permita que todas las hojas de la segadora detengan su rotación antes de levantar las secciones del ala durante otras operaciones.

Seguridad durante el segado de los bordes de las zanjas

Use cuidado extremo cuando sigue los bordes de las zanjas. Vigile para ver si hay derrumbes, áreas erosionadas y obstrucciones para el segado a lo largo del borde de la zanja. El extremo delantero del tractor puede desviarse hacia la zanja al golpear las obstrucciones con las segadoras de montaje lateral o de pescante.

Las operaciones con segadoras con alas levantadas y pescantes pueden reducir la efectividad del blindaje para objetos despedidos de la segadora que sirven para proteger al operador.

Para aumentar la protección del operador de objetos despedidos durante las operaciones en los bordes de las zanjas:

- Use cabinas cerradas con una estructura contra vuelcos (ROPS), cubiertas protectoras especiales y otros blindajes para el operador, cuando efectúe estas operaciones.
- Inspeccione el área de segado y retire o marque todos los objetos extraños y desechos que deben evitarse con la segadora.





Seguridad durante el segado de terreno accidentado

La estabilidad del tractor y segadora se reduce en las pendientes y terreno accidentado.

Usted puede evitar el vuelco del tractor y segadora y mantener el control de la estabilidad del equipo haciendo lo siguiente:

- Revisando los manuales del operador del tractor y segadora para conocer las prácticas de seguridad de operación en pendientes y terreno accidentado. Explique las prácticas a los usuarios u operadores que no puedan leer.
- Evitando operar en pendientes extremadamente inclinadas.
- Usando cuidado extremo para mantener el control sobre su equipo cuando opere en estas condiciones.
- Aumentando la estabilidad del tractor, agregando pesas a las ruedas y aumentando el espacio entre las mismas, (haga referencia al manual del operador del tractor para conocer las recomendaciones).
- Usando un tractor equipado con una estructura contra vuelcos (ROPS) y cinturón de seguridad para la seguridad del operador durante las operaciones de segado.
- Manteniendo una velocidad absoluta mínima.
- Haciendo virajes anchos y graduales.
- Evitando arranques, paradas y virajes repentinos cuando opere subiendo, bajando o atravesando las pendientes.
- No subiendo del suelo las segadoras montadas atrás o lateralmente ni las alas de segado durante estas operaciones.
- Manteniéndose alerta por si hubiera agujeros, baches, surcos, piedras, troncos u otras obstrucciones que podrían volcar el tractor y segadora.
- Evitando las condiciones de suelo resbaloso que podrían volcar el tractor y segadora.
- Evitando que el tractor y segadora queden atascados al pasar diagonalmente sobre declives y bajadas escarpadas pronunciadas.

Use extremo cuidado para mantener la estabilidad del equipo durante todas las operaciones sobre terreno accidentado y pendientes. Usted tiene la palabra final referente a cualquier pendiente que pueda ser trabajada en forma segura.

Seguridad durante el transporte del equipo en caminos

Si es necesario conducir el equipo sobre los caminos públicos:

- Haga referencia al manual del operador del fabricante del tractor y segadora para conocer las instrucciones.
- Explique las instrucciones a los usuarios u operadores que no puedan leer.
- Verifique las reglamentaciones locales referentes a las marcas, luces, luces intermitentes, etc., requeridas del equipo para el desplazamiento sobre caminos públicos. Se requiere de luces para las segadoras que obstruyen las luces traseras del tractor y/o las luces de advertencia.

Antes del transporte en caminos públicos:

- Desenganche la toma de fuerza (PTO) conectada a la segadora.
- Suba la segadora a la posición de transporte.
- Asegure las alas en la posición de transporte con los seguros en las segadoras de tipo ala y de montaje lateral.
- Enganche la cadena de seguridad entre la segadora de tipo tiro y el tractor.
- Asegúrese de que las luces, luces intermitentes, reflectores y avisos de vehículo de movimiento lento (SMV) están colocados y visibles.
- Revise que el emblema de vehículo de movimiento lento (SMV) sea visible para cualquier vehículo que se acerque desde atrás.

Cuando transporte en caminos públicos:

- Obedezca todas las reglamentaciones locales de tráfico.
- Acérquese a las intersecciones con precaución.
- Cumpla con los avisos de velocidad y de control de tráfico.
- Evite las paradas bruscas y doblar repentinamente.

Seguridad durante el estacionamiento

Estacione el equipo en:

- Áreas designadas o alejadas del tráfico.
- Preferentemente utilice lugares en terreno nivelado.

Lugares de estacionamiento en terreno inclinado:

- Coloque el equipo en posición transversal en las pendientes.
- Aplique los frenos de estacionamiento.
- Baje la segadora al suelo.
- Coloque bloques en las ruedas del tractor.

Antes de estacionar temporalmente y abandonar el equipo incapacitado cerca de áreas con tráfico:

- Retire el equipo de los caminos públicos.
- Coloque las banderas de advertencia.
- Use las luces intermitentes del tractor.

Seguridad durante la parada

Para su seguridad use las prácticas apropiadas para la parada del equipo

Haga referencia al (los) manual(es) del operador del fabricante del tractor y segadora para conocer los procedimientos de parada recomendados. Explique los procedimientos a los usuarios u operadores que no puedan leer.

Haga que los procedimientos apropiados de parada del equipo sean una costumbre importante que se debe practicar. Siga estas prácticas de seguridad antes de bajarse del tractor:

- Desenganche el embrague y transmisión de la toma de fuerza (PTO).
- Para que el motor enfríe gradualmente permita que funcione al ralentí.
- Coloque los controles en estacionamiento (P) o en punto muerto (N).
- Coloque el freno de estacionamiento.
- Baje la segadora al suelo.
- Baje al suelo las alas de las segadoras de tipo ala.
- Apague el motor.
- Espere a que todas las piezas movibles se detengan antes de efectuar inspecciones, ajustes o reparaciones al equipo.
- Descargue la presión hidráulica moviendo los controles hidráulicos varias veces en todas las direcciones.
- Asegure la ignición y extraiga la llave cuando el equipo debe ser inspeccionado, reparado, ajustado o va a permanecer desatendido.
- Asegure las cubiertas contra el vandalismo cuando el equipo permanece desatendido.
- Baje cuidadosamente manteniendo un contacto de tres puntos.

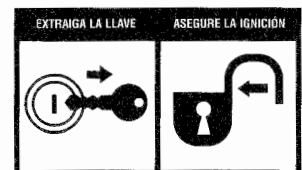
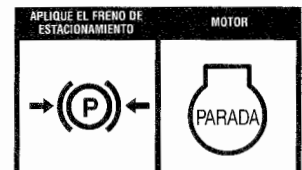
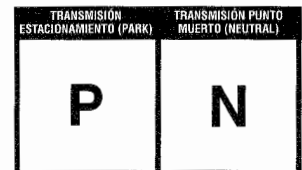
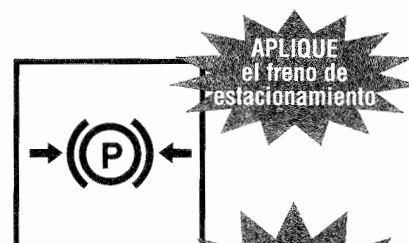

ESPERE que las piezas móviles se detengan antes de bajar

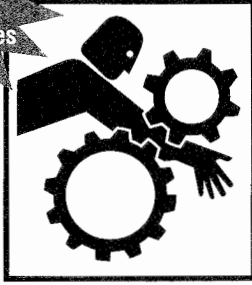

USE el contacto de tres puntos



DE MANTENIMIENTO a su equipo

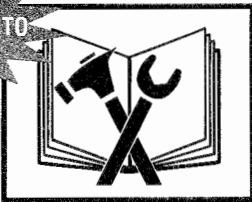

CUMPLA

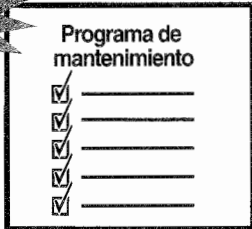

Seguridad durante la bajada del tractor

Antes de bajar del tractor haga lo siguiente:

- Para su seguridad, use las prácticas apropiadas para la parada del equipo.
- Baje el implemento al suelo, apague el motor y la toma de fuerza (PTO), aplique los frenos, permita que se detengan todas las piezas móviles y extraiga la llave antes de bajar del tractor.
- Nunca baje del equipo cuando esté en movimiento.
- Nunca salte de las máquinas.
- Baje cuidadosamente.
- Verifique que los escalones no estén resbalosos.
- Mantenga los pies y manos alejados de los controles.
- Use las asas para las manos y los escalones para bajar.
- Vea hacia la máquina y use el contacto de 3 puntos (2 manos, 1 pie ó 2 pies, 1 mano).

Seguridad durante el mantenimiento

Seguridad durante el mantenimiento

Para su seguridad haga lo siguiente antes de efectuar procedimientos de mantenimiento, reparación o servicio:

- Cumpla con la práctica apropiada para la parada del equipo.
- Use toda la ropa protectora y equipo de seguridad personal necesarios para efectuar el trabajo en forma segura.
- Haga referencia a sus manuales del fabricante para conocer los procedimientos correctos de mantenimiento, reparación y servicio. Explique los procedimientos a los usuarios y operadores que no puedan leer.

Las fuentes de energía almacenada (eléctrica, mecánica, hidráulica, neumática, química, térmica etc.) deben estar aseguradas, bloqueadas, descargadas, desconectadas, apagadas, aseguradas, neutralizadas, controladas o reducidas a un mínimo práctico, antes de efectuar con seguridad cualquier procedimiento de mantenimiento, reparación o servicio.

Algunas prácticas de seguridad básicas para evitar posibles lesiones causadas por las fuentes que emiten energía:

- Desenganche la toma de fuerza (PTO) antes de apagar el motor.
- Coloque los controles en estacionamiento (P) o punto muerto (N) antes de apagar el motor.
- Aplique el freno de estacionamiento o coloque bloques en las ruedas.
- Permita que todas las piezas movibles se detengan.
- Baje la segadora al suelo.
- En las segadoras de tipo ala, baje las alas al suelo.
- Apague el motor del tractor.
- Asegure la ignición y extraiga la llave.
- Observe y escuche para establecer si hay piezas en movimiento antes de abrir los blindajes.
- Soporte o coloque bloques firmemente debajo de la segadora antes de trabajar debajo de la segadora u otros componentes elevados.
- Soporte, coloque bloques o asegure firmemente las alas de la segadora con los seguros antes de trabajar cerca o debajo de una segadora de tipo ala.
- Descargue la presión del sistema hidráulico moviendo los controles varias veces en todas direcciones.
- Descargue la presión antes de desconectar o desensamblar cualquier sistema presurizado.
- Coloque bloques o descargue la presión del resorte antes de desensamblar cualquier dispositivo a resorte.
- Soporte o bloquee firmemente cualquier componente de la máquina que esté elevado, antes de trabajar en ella.
- Evite las llamas, chispas o fumar cerca de cualquier combustible.



Su seguridad y las piezas del fabricante para la segadora

La mayoría de los fabricantes de segadoras usan sujetadores y piezas especialmente diseñadas para cumplir con los requerimientos de la operación de segado.

Seguridad crítica – piezas relacionadas (pernos de la hoja autoasegurados, hojas, pasadores, blindajes u otros artículos especiales) tienen requerimientos de fuerza, diseño y encaje específicos para el estilo y modelo de la segadora que usted utiliza.

Las modificaciones o piezas para reparación que no son aprobadas por el fabricante de la segadora pueden causar un riesgo significativo por exposición a su seguridad y la de los demás.

PARA EVITAR LAS LESIONES SERIAS O LA MUERTE CAUSADAS POR PIEZAS O MODIFICACIONES NO APROBADAS:

- No sustituya accesorios comunes por los pernos autoasegurados de las hojas u otras piezas especiales.
- No sustituya las hojas, pasadores, blindajes u otras piezas relacionadas con la seguridad crítica.
- No use pernos de grado 5 u 8 para reemplazar los pernos de resistencia limitada grado 2.

CUMPLA LA PRÁCTICA SEGURA DE SIEMPRE VERIFICAR EL FUNCIONAMIENTO CORRECTO DE TODOS LOS AJUSTES, REPARACIONES O SERVICIO DE LA SEGADORA.



Palabra final

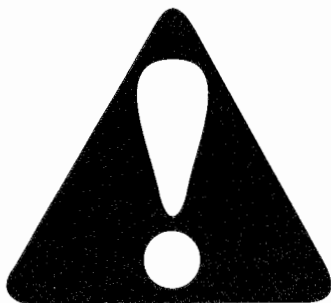

Usted ha terminado de leer el manual de seguridad de la segadora. Es imposible que este manual incluya toda situación peligrosa potencial que usted pueda encontrar. Sin embargo, su conocimiento de estas precauciones de seguridad y su cumplimiento de las reglas básicas de seguridad le ayudarán a crear buen juicio para todas las situaciones. Nuestro objetivo es ayudarle a desarrollar buenos hábitos de seguridad y hacerlo un mejor operador de segadora. El manual de seguridad de la segadora, precauciones de seguridad y reglas básicas de seguridad deben explicarse a los usuarios u operadores que no puedan leer.

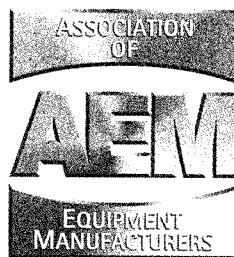

111 E. Wisconsin Avenue • Milwaukee, Wisconsin 53202 U.S.A.
www.aem.org

Para obtener información de reproducciones adicionales y
otros manuales de seguridad, llame al 800-369-2310

INTRODUCTION SECTION

Introduction Section 2-1

INTRODUCTION

INTRODUCTION

This Mower is designed with care and built with quality materials by skilled workers. Proper assembly, maintenance, and operating practices, as described in this manual, will help the owner/operator get years of satisfactory service from the machine.

The purpose of this manual is to familiarize, and instruct. The Assembly Section instructs the owner/operator in the correct assembly of the Mower using standard and optional equipment. The Parts Listing section is designed to familiarize the owner/operator with replaceable parts on the Mower. This section provides exploded assembly drawings of each mower component illustrating each piece and the corresponding part number.

Careful use and timely service saves extensive repairs and costly downtime losses. The Operation and Maintenance Sections of the manual train the owner/operator how to work the Mower correctly and attend to appropriate maintenance. The Trouble Shooting Guide helps diagnose difficulties with mower and offers solutions to the problems.

Safety is of primary importance to the owner/operator and to the manufacturer. The first section of this manual includes a list of Safety Messages, that, if followed, will help protect the operator and bystanders from injury or death. Many of the Safety Messages will be repeated throughout the manual. The owner/operator/dealer should know these Safety Messages before assembly and be aware of the hazards of operating this mower during assembly, use, and maintenance. The Safety Alert Symbol combined with a Signal Word, as seen below, is intended to warn the owner/operator of impending hazards and the degree of possible injury faced when operating this machine.



Indicates an imminently hazardous situation that, if not avoided, WILL result in DEATH OR VERY SERIOUS INJURY.



Indicates an imminently hazardous situation that, if not avoided, COULD result in DEATH OR SERIOUS INJURY.



Indicates an imminently hazardous situation that, if not avoided, MAY result in MINOR INJURY.

Important

Identifies special instructions or procedures that, if not strictly observed, could result in damage to, or destruction of the machine, attachments or the environment.

INTRODUCTION



INTRODUCTION

These Rotary Mowers are designed for medium-duty work. They can mow pastures and control grass and weeds on highways or industrial sites up to 3" in diameter.

Your Cutter has been assembled for operation with a tractor PTO input speed of either 540 or 1000 PTO speed. Should you desire to change PTO input speed, contact you local Alamo Industrial dealer who will assist you in performing the necessary modifications. This machine is recommended for use with tractors rated 50 hp (37kw) for 540 and 1000 PTO Speed drive.

⚠ DANGER

For Non-Agricultural use, OSHA, ASAE, SAE and ANSI standards require the use of Chain Guards, Deflectors, or Solid Skirts at all times. The Mower manufacturer strongly recommends the use of Chain Guards, Deflectors, or Solid Skirts for Agricultural purposes as well to reduce the risk of property damage, serious bodily injury, or even death from objects thrown out by or from contact with the Cutting Blades.

⚠ WARNING

At least 20% of the tractor's total weight must be on the front tires with the Mower lifted to provide adequate traction for safe steering under good conditions. Slow down on hills, rough terrain, and curves.

Front and rear, and left and right are determined by the normal direction of travel (the same as on your automobile).

INTRODUCTION

ATTENTION OWNER/ OPERATOR

BEFORE OPERATING THIS MACHINE:

1. Carefully read the Operator's Manual, completely understand the Safety Messages and instructions, and know how to operate correctly both the Mower and Power Unit.
2. Fill out the Warranty Card in full. Be sure to answer all questions, including the Serial Number of the Mower. Mail promptly using the return envelope included with the Operator's Manual.

NOTE: Warranties are honored only if completed "Owner Registration and Warranty" forms are received by Alamo Group within thirty days of delivery of the mower.

3. Record the Mower Model and Serial Numbers on the Warranty page at the end of the Operator's Manual. Keep this as part of the permanent maintenance file for the Mower.

IMPORTANT

For your safety and to guarantee optimum product reliability, always use Genuine ALAMO INDUSTRIAL replacement parts. The use of inferior "will-fit" parts will void Warranty of your ALAMO INDUSTRIAL implement and may cause premature or catastrophic failure which can result in serious injury or death. If you have any questions concerning the repair parts you are using, contact ALAMO INDUSTRIAL, 1502 E. Walnut Seguin, TX 78155 (830) 372-3551.

 **ALAMO**
INDUSTRIAL

02925100

ASSEMBLY SECTION

Assembly Section 3-1

ASSEMBLY



PROPER TORQUE VALUES FOR FASTENERS

The chart (found on Section 3-3) lists the correct tightening torque for fasteners. When bolts are to be tightened or replaced, refer to this chart to determine the grade of bolts and the proper torque except when specific torque values are assigned in manual text.





RECOMMENDED TORQUE IN FOOT POUNDS UNLESS OTHERWISE STATED IN THE MANUAL *

NOTE: These values apply to fasteners as received from supplier, dry or when lubricated with normal engine oil. They do not apply if special graphitic or molydisulphide greases or other extreme pressure lubricants are used. This applies to both UNF fine and UNC coarse threads.

Proper Torque values for bolts that are measured in Inches

Bolt Diameter			
	Head Marking No Marks Grade Two Pound - Foot Value Dry	Head Marking Three Lines Grade Five Pound - Foot Value Dry	Head Marking Six Lines Grade Eight Pound - Foot Value Dry
1/4"	5.5	9	12.5
5/16"	11	18	26
3/8"	20	33	46
7/16"	32	52	75
1/2"	50	80	115
9/16"	70	115	160
5/8"	100	160	225
3/4"	175	280	400
7/8"	175	450	650
1"	270	675	975
1-1/8"	375	850	1350
1-1/4"	530	1200	1950
1-3/8"	700	1550	2550
1-1/2"	930	2100	3350

Proper Torque values for Metric bolts

Bolt Diameter				
	Head Marking 4.8 Pound - Foot Value Dry	Head Marking 8.8 or 9.8 Pound - Foot Value Dry	Head Marking 10.9 Pound - Foot Value Dry	Head Marking 12.9 Pound - Foot Value Dry
6mm	4.5	8.5	12	14.5
8mm	11	20	30	35
10mm	21	40	60	70
12mm	37	70	105	120
14mm	60	110	165	190
16mm	92	175	265	300
18mm	125	250	350	410
20mm	180	350	500	580
22mm	250	475	675	800
24mm	310	600	850	1000
27mm	450	875	1250	1500
30mm	625	1200	1700	2000

*To get Newton-Meters multiply pound-foot of torque by 1.356

CONNECTING THE MOWER TO THE TRACTOR

Use extreme caution when connecting the mower to the tractor. The mower should be securely resting at ground level or setting on blocks. Keep hands and feet from under the mower deck and clear of pinch points between the tractor hitch arms and mower pins. OPS-R-0001



Always shut the Tractor completely down, place the transmission in park, and set the parking brake before you or anyone else attempts to connect or disconnect the Implement and Tractor hitches. (S3PT-15)

ASSEMBLY

Connecting the Mower Tongue to the Tractor

1. Ensure the tractor is equipped with the correct PTO shaft and the drawbar is set at the correct length.
2. Using the parking jack, position the tongue clevis to the height of the tractor drawbar. Adjust the mower tongue to be level and parallel with the tractor drawbar using the control rod connecting the mower tongue to the deck.
3. Board the tractor and start the engine. Back the tractor to the mower aligning the drawbar hitch hole with the mower tongue clevis. Turn off the tractor engine, place the tractor in park, and set the parking brake before dismounting.
4. To attach the mower, place a 1" washer (1) under top lip of welded Clevis. Add enough 1" spacer washers (2) between bottom of drawbar and bottom lip of Clevis and tighten the 1" locknut & bolt securely. **Note: Attaching a Falcon mower to the tractor 3-Point Hitch IS NOT RECOMMENDED UNDER ANY CONDITIONS.**
5. Securely attach the mower safety chain to the tractor drawbar or drawbar support frame.
6. Lower the jack until the tongue is completely supported by the drawbar. Remove jack from the tongue and place on storage bracket of mower.

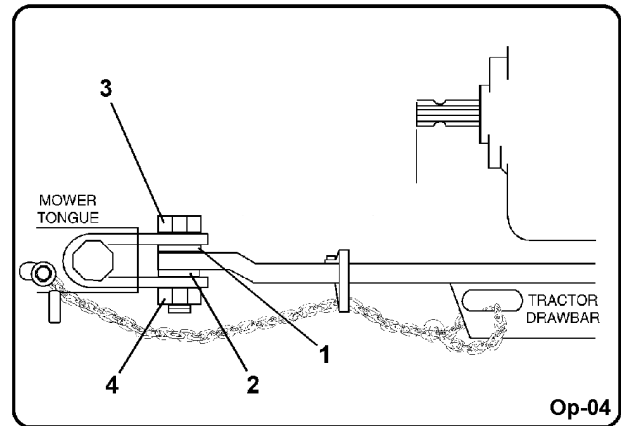
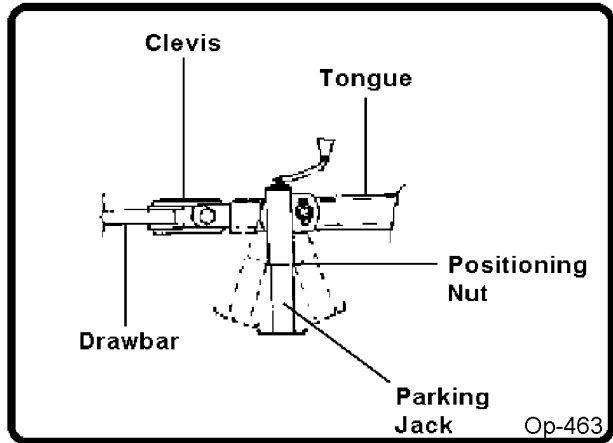

Safety Tow Chain

If the mower is towed on a public roadway, a safety chain with tensile strength equal to or greater than the gross weight of the mower must be connected between the tractor and mower. This will help control the implement in the event the tongue becomes disconnected from the drawbar. Make sure the chain is attached to a secure location on the tractor and not to an intermediate support.

After connecting both ends of the safety chain, drive the tractor to the right and left to check for proper chain length. Adjust length as necessary and allow only enough slack in the chain to make a maximum turn in both directions. When not in use, store the safety chain to protect it from mud or standing water by wrapping the chain around the tongue. Replace the safety chain if one or more links or end fittings are broken, stretched or otherwise damaged or deformed. OPS-U-0039

ASSEMBLY

ASSEMBLY

PUMP, SPEED INCREASER AND CUTTER ATTACHMENT

To attach the Speed Increaser, Cutter and Pump to the tractor, use the following procedure:

7. Attach the Speed Increaser Mount Plate to the tractor loosely. Refer to the installation drawing, supplied in the packing box, for specific instructions.
8. Grease the tractor PTO shaft and slide the Speed Increaser on. Install the 1/2" bolts and bushings between the Speed Increaser and Mount Plate. Do not tighten bolts at this time.
9. With the tractor in idle and the PTO engaged, alternate tightening the Mount Plate bolts following an "X" pattern until they have all been tightened. Refer to Torque Chart for proper torque.
10. Turn off the tractor engine, place the tractor in park, and set the parking brake before dismounting. Then attach the cutter tongue to tractor drawbar with bolt, washers and locknut.
11. Grease the inside and outside of the Splined Adapter Bushing and insert it into the Speed Increaser. Slide the Pump in place and tighten the mounting bolts.



NOTE: When attaching the pump to the speed increaser, reposition the angle of the hose fittings on the pump to allow sufficient hose movement so that the hoses won't crimp or twist while in operation. (ex. going through dips and uneven terrain)

WARNING

Do not operate this Equipment with hydraulic oil or fuel leaking. Oil and fuel are explosive and their presence could present a hazard. Do not check for leaks with your hand! High-pressure oil streams from breaks in the line could penetrate the skin and cause tissue damage including gangrene. To check for a hose leak, SHUT the unit ENGINE OFF and remove all hydraulic pressure. Wear oil impenetrable gloves, safety glasses and use Cardboard to check for evidence of oil leaks. If you suspect a leak, REMOVE the HOSE and have it tested at a Dealer. If oil does penetrate the skin, have the injury treated immediately by a physician knowledgeable and skilled in this procedure. (SG-15)



ASSEMBLY

ATTACHING CYLINDER HOSES

Attach cylinder hoses to Tractor QD Remotes (Requires Three Spool Tractor Remote Valve to Operate Each Wing and Axle Independently) or use Three Spool Control Valve Option. Proper QD couplers will need to be attached to hydraulic hoses.

Operating Mower Hydraulics with Three Tractor Hydraulic Ports

Connect one hose into each hydraulic port. Connect lines to correspond with position of hydraulic control levers.

Operating Mower Hydraulics with Two Tractor Hydraulic Ports

The lines that operate the wings must be plumbed together and will be controlled using one hydraulic control valve and the center section with the remaining control valve. Ensure that the operator is aware that each wing cannot be controlled independently nor will they raise and lower simultaneously.

ATTACHING ELECTRICAL CONNECTIONS

Attach the free ends of the mower wire harness to a switched power supply of the tractor (Requires 25 Amp Minimum Service). Alamo industrial suggest using the Tractor Auxiliary Power Connector inside the tractor. (If tractor is equipped) The Connector is available from the tractor dealer. If desired, a switch, rated at 25 amp min, can be installed in the power supply line to selectively turn the unit off and on.

LEVELING UNIT

The mower Must Be Leveled after attaching to the tractor. To level the implement correctly refer to Section 7 SETTING THE MOWER of the Operators Section of this manual.

ASSEMBLY

WINCH ASSEMBLY ATTACHMENT (OPTIONAL EQUIPMENT)

Attach the Winch Stand to the cross bar on the Center Section with bolts and locknuts. Attach the Winch to the Winch Stand with bolts and locknuts. See Operation Section for use.

Three Spool Control Valve Installation (OPTIONAL EQUIPMENT)

A Three-Spool Control Valve is available from your dealer for use with tractors having either an open or closed center Hydraulic System. If a 3 spool valve bank is required assemble on bracket and install on tractor fender at desired location. Refer to Parts List Section. To install the hydraulics from the Mower to the Control Valve, connect the Center Axle Lift Cylinder Hose to the Right Port on the Hydraulic Valve. Connect the Wing Folding Cylinder Hoses to the same side of the Control Valve as the Cylinder are on the Mower rather than crossing the Hoses. Route hoses through front and rear hose brackets. Remove plastic plug from Breather of Cylinder before operation.

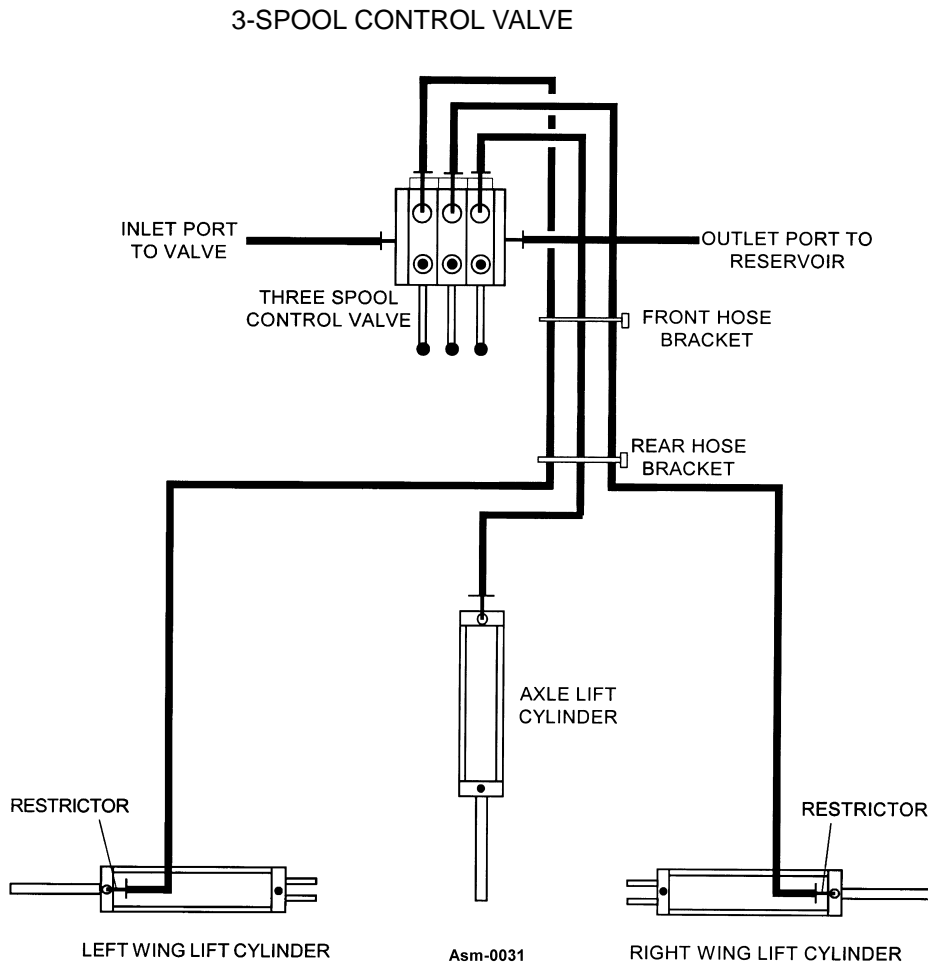

ASSEMBLY

TIRES AND WHEELS(OPTIONAL WHEEL CONFIGURATIONS)

Before installing any tires and wheels make certain the Cutter is jacked up high enough and is securely supported. When installing laminated or airplane tires, be sure the flat side of the lug nut is against the Wheel. There are only three types of tires that can be used on this cutter DO NOT USE ANY OTHER TYPE OF TIRE OR WHEEL, such as automotive tires and rims. DO NOT EXCEED THE MAXIMUM SPEED FOR EACH TYPE OF TIRE. As excessive speed can cause damage to the machine, tire, and wheel.

When installing Sectional Tires and Wheels note the direction of travel and the curvature of rubber segments in the tire and install as shown in **FIGURE Asm-R-0213**. Do not exceed 15 M.P.H. on Sectional Tires. When removing Airplane Tires, let all of the air out of the tire before removing lug nuts or wheel bolts or nuts. Remove valve core to make certain that there is no air pressure left in tube before separating wheel halves to dismount tires. DO NOT LOOSEN WHELL CLAMP BOLTS BEFORE PRESSURE IS REMOVED FROM TUBE AND TIRE TO PREVENT EXPLOSIVE SEPERATION OF WHEEL HALVES WITH POSSIBLE SERIOUS BODILY INJURY. Do not exceed 20 M.P.H. on Airplane or Rib Implement Tires.

Maximum airplane tire inflation pressure is 50 PSI, minimum inflation pressure is 20 PSI. Inflate ribbed implement tires to manufacturer rated PSI as shown on the tire sidewall

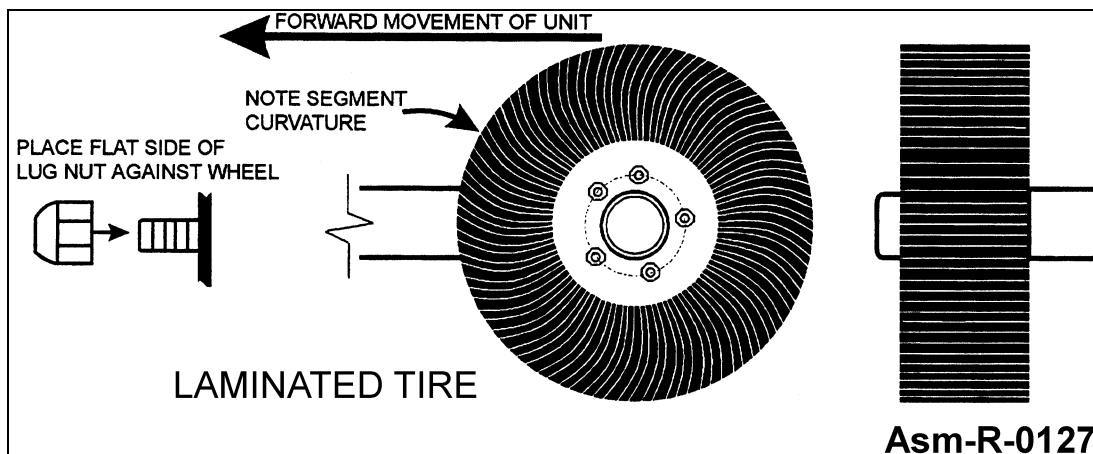

CAUTION

FAILURE TO FOLLOW SAFETY MESSAGES MAY CAUSE BODILY INJURY AND/OR TIRE AND WHEEL AND/OR EQUIPMENT DAMAGE. BE CAREFUL.

1. MAXIMUM inflation pressure 50 PSI to help prevent tire blowouts. MINIMUM inflation pressure 20 PSI.
2. MAXIMUM transport speed 20 MPH to help prevent overheating and blowouts which may cause injuries.
3. Remove valve core to make certain there is no air pressure left in tube before separating wheel halves to dismount tire. DO NOT LOOSEN WHELL CLAMP BOLTS BEFORE PRESSURE IS REMOVED FROM TUBE AND TIRE TO PREVENT EXPLOSIVE SEPERATION OF WHEEL HALVES WITH POSSIBLE SERIOUS BODILY INJURY.
4. Never mount any other tire (such as a truck tire) on this wheel supplied with a 22-ply aircraft tire. 00762608

ASSEMBLY

Asm-R-0213

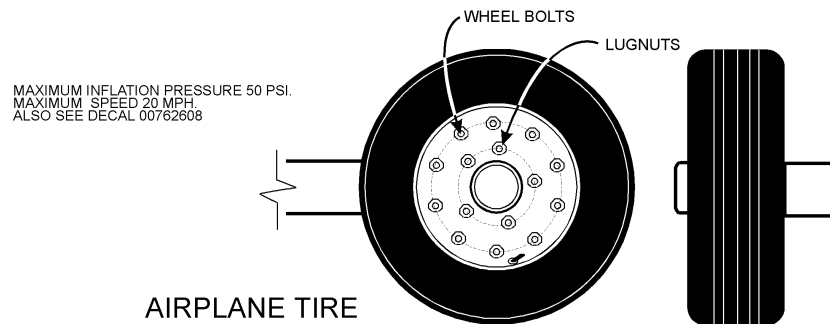
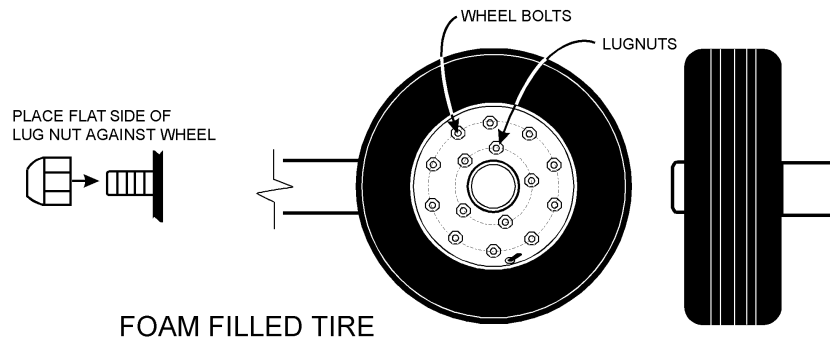
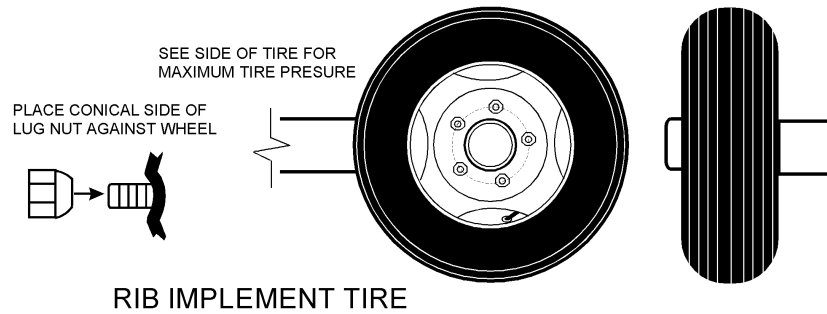

ASSEMBLY

OPERATION SECTION

Operation Section 4-1

OPERATION

ALAMO INDUSTRIAL FALCON 15/10 OPERATING INSTRUCTIONS

Alamo Industrial mowers are manufactured with quality material by skilled workers. These mowers are designed for cutting grass and small weeds. The mower is equipped with protective deflectors to prevent objects being thrown from the mower by the blades, however, no shielding is 100% effective. All shields, guards, and deflectors equipped on the mower must be maintained in good operational condition.

It is the operator's responsibility to be knowledgeable of all potential operating hazards and to take every reasonable precaution to ensure oneself, others, animals, and property are not injured or damaged by the mower, tractor, or a thrown object. Do not operate the mower if passersby, pets, livestock, or property are within 100 yards of the unit.

This section of the Operator's Manual is designed to familiarize, instruct, and educate safe and proper mower use to the operator. Pictures contained in this section are intended to be used as a visual aid to assist in explaining the operation of a rotary mower and are not specific to any model. Some pictures may show shields removed for picture clarity. NEVER operate implement without all shields in place and in good operational condition. The operator must be familiar with the mower and tractor and all associated safety practices before operating the mower and tractor. Proper operation of the mower, as detailed in this manual, will help ensure years of safe and satisfactory use of the mower.

IMPORTANT: To avoid mower damage, retorque all bolts after the first 10 hours of operation. Refer to the Torque Chart at the end of the Maintenance Section to ensure bolts are properly tightened.

READ AND UNDERSTAND THE ENTIRE OPERATING INSTRUCTIONS AND SAFETY SECTION OF THIS MANUAL AND THE TRACTOR MANUAL BEFORE ATTEMPTING TO USE THE TRACTOR AND IMPLEMENT. If you do not understand any of the instructions, contact your nearest authorized dealer for a full explanation. Pay close attention to all safety signs and safety messages contained in this manual and those affixed to the implement and tractor. *OPS-U-0001*

READ, UNDERSTAND, and FOLLOW the following Safety Messages. Serious injury or death may occur unless care is taken to follow the warnings and instructions stated in the Safety Messages. Always use good common sense to avoid hazards. (SG-2)

SAFETY INSTRUCTIONS



PELIGRO

Si no lee ingles, pida ayuda a alguien que si lo lea para que le traduzca las medidas de seguridad. (SG-3)

¡ LEA EL INSTRUCTIVO!



OPERATION

1. Standard Equipment and Specifications

Cutting Width	15'10'
Cutting Height	1-1/2" - 14-1/2" with pneumatic tires
Updraft Blades	1/2" x 4" x 24-1/2", constructed of carbon-chrome spring steel which are forged and heat-treated
Hitch	Self-leveling Clevis Hitch
Deck	made of 7-gauge steel
Side Skirts	1/4" x 10-1/2"
Reservoir	35-Gallon with Dual Filtration
Pump	145 HP Dual Stage Gear-type
Lift Rods	Dual Level
Wing Motor Cutoff	Standard
Chainguards	Double Row with 5/16" chain
Axles	Spring Cushioned
Wings	Hydraulically Folding
Blade Carrier	Pan
Blades	Updraft
Replaceable Skid Shoes	Standard

OPERATION

2. OPERATOR REQUIREMENTS

Safe operation of the unit is the responsibility of a qualified operator. A qualified operator has read and understands the implement and tractor Operator's Manuals and is experienced in implement and tractor operation and all associated safety practices. In addition to the safety messages contained in this manual, safety signs are affixed to the implement and tractor. If any part of the operation and safe use of this equipment is not completely understood, consult an authorized dealer for a complete explanation.

If the operator cannot read the manuals for themselves or does not completely understand the operation of the equipment, it is the responsibility of the supervisor to read and explain the manuals, safety practices, and operating instructions to the operator.

Safe operation of equipment requires that the operator wear approved Personal Protective Equipment (PPE) for the job conditions when attaching, operating, servicing, and repairing the equipment. PPE is designed to provide operator protection and includes the following safety wear:

PERSONAL PROTECTIVE EQUIPMENT (PPE)

- Protective Eye Glasses, Goggles, or Face Shield
- Hard Hat
- Steel Toe Safety Footwear
- Gloves
- Hearing Protection
- Close Fitting Clothing
- Respirator or Filter Mask (depends on operating conditions) *OPS-U- 0002*

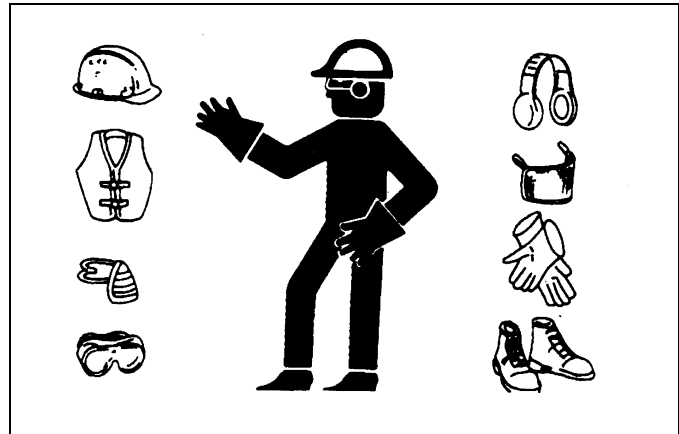

⚠ DANGER

NEVER use drugs or alcohol immediately before or while operating the Tractor and Implement. Drugs and alcohol will affect an operator's alertness and coordination and therefore affect the operator's ability to operate the equipment safely. Before operating the Tractor or Implement, an operator on prescription or over-the-counter medication must consult a medical professional regarding any side effects of the medication that would hinder their ability to operate the Equipment safely. NEVER knowingly allow anyone to operate this equipment when their alertness or coordination is impaired. Serious injury or death to the operator or others could result if the operator is under the influence of drugs or alcohol. (SG-27)

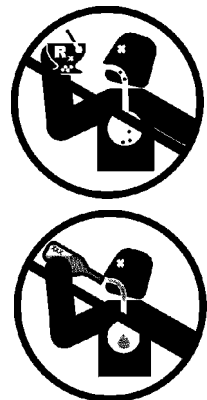

OPERATION

3. TRACTOR REQUIREMENTS

In addition to tractor horsepower and size required to operate the mower unit, the tractor must also be properly equipped to provide operator protection, to alert approaching vehicle drivers of the tractor's presence, and to ensure tractor stability when mowing with the boom fully extended.

Tractor Requirements and Capabilities

- ASAE approved Roll-Over Protective Structure (ROPS) or ROPS cab and seat belt.
- Tractor Safety Devices Slow Moving Vehicle (SMV) emblem, lighting, PTO master shield
- Tractor Horsepower-Minimum Falcon 10 40HP; Falcon 15 50HP
- -Maximum..... 540 RPM Unit-100 HP; 1000 RPM Unit 140 HP
- Hydraulics..... Wing Hydraulic Motors rated at 70 HP @ 2000 PSI
Center Hydraulic Motor rated at 75 HP @ 3000 PSI
- Power Take Off..... 540 RPM
- Tire Wheel Spacing Set tires minimum width of 60" from inside to inside of tires.

3.1 ROPS and Seat Belt

The tractor must be equipped with a Roll-Over-Protective-Structure (ROPS) (tractor cab or roll-bar) and seat belt to protect the operator from falling off the tractor, especially during a roll over where the driver could be crushed and killed. Only operate the tractor with the ROPS in the raised position and seat belt fastened. Tractor model not equipped with a ROPS and seat belt should have these life saving features installed by an authorized dealer. *OPS-U- 0003*



Operate this Equipment only with a Tractor equipped with an approved roll-over-protective system (ROPS). Always wear seat belts. Serious injury or even death could result from falling off the tractor--particularly during a turnover when the operator could be pinned under the ROPS. (SG-7)



3.2 Tractor Safety Devices

If transporting or operating the tractor and implement near a public roadway, the tractor must be equipped with proper warning lighting and a Slow Moving Vehicle (SMV) emblem which are clearly visible from the rear of the unit. Lights and a SMV emblem must be equipped directly on implements if the visibility of the tractor warning signals are obscured.

Maintain all manufacturer equipped safety shields and guards. Always replace shields and guards that were removed for access to connect, service, or repair the tractor or implement. Never operate the tractor PTO with the PTO master shield missing or in the raised position. *OPS-U- 0004*

3.3 Tractor Horsepower

The horsepower required to operate the mower depends on many factors including vegetation to be cut, terrain condition, operator experience, and condition of the mower and tractor. For most mowing condition, the Falcon 10 rotary mower require a tractor with at least 40 HP and 50 HP for Falcon 15. Operating the mower with a tractor that does not have adequate power may damage the tractor engine.

OPERATION

3.4 Hydraulics

A Three-Spool Control Valve (Extra Equipment) is available from your dealer for use with tractors having either an open or closed center Hydraulic System. The Control Valve Handles should be set in the float position for most Cutter operations. This will allow the Cutter sections to follow the contour of the land. In the float position, the Control Valve Handles are pushed in the closest to the Valve body. The closed-center Valve Handles must be kept in the float position to keep the Wings and Center Section from creeping up. When extending the left or right Wing out over a ditch when mowing, put the Control Valve Handles with detents in the center position on the Valve. This will give the Cutter more stability and prevent the opposite Wing from raising. Do not operate Cutter in this position over rough terrain or for long periods of time.

3.5 Front End Weight

A minimum of 20% total tractor weight must be maintained on the tractor front end at all times. Front end weight is critical to maintain steering control and to prevent the tractor from rearing up while driving. If the front end is too light, add weight until a minimum of 20% total weight is reached on the front tires. Front weights and weight carriers can be purchased through an authorized tractor dealership. *OPS-U- 0005*

3.6 Power Take Off (PTO)

Depending on the unit, the mower is designed to operate at a PTO speed of 540 or 1000 RPM. Most tractors operate at either 540, or a combination of 540 and 1000 RPM PTO speeds. The operating speed of the mower and tractor can be determined by the number of splines on the driveline yoke and PTO output shaft. Those operating at 540 RPM will have a 6-spline shaft and those operating at 1000 RPM will have a 21-spline shaft or a 1-3/4" 20 spline shaft. Refer to the tractor owner's manual for instructions to change PTO speeds on models that operate at more than one speed.

If operating an older model tractor where the tractor's transmission and PTO utilize one master clutch, an over-running clutch must be used between the PTO output shaft and the driveline of the mower. An authorized tractor dealer can provide the over-running clutch and its installation if needed. *OPS-U- 0006*



DO NOT use a PTO adapter to attach a non-matching Implement driveline to a Tractor PTO. Use of an adapter can double the operating speed of the Implement resulting in excessive vibration, thrown objects, and blade and implement failure. Adapter use will also change the working length of the driveline exposing unshielded driveline areas. Serious bodily injury and/or equipment failure can result from using a PTO adapter. Consult an authorized dealer for assistance if the Implement driveline does not match the Tractor PTO.

(S3PT-14)



Never operate the Tractor and Mower if the Implement input driveline is directly connected to the Tractor transmission. Tractor braking distances can be substantially increased by the momentum of the rotating Mower blades driving the Tractor transmission even though the Tractor clutch has been disengaged. Install an over running clutch between the Tractor PTO and the Mower driveline to prevent this potentially dangerous situation. (S3PT-16)

OPERATION

4. GETTING ON AND OFF THE TRACTOR

Before getting onto the tractor, the operator must read and completely understand the implement and tractor operator manuals. If any part of either manual is not completely understood, consult an authorized dealer for a complete explanation. *OPS-U- 0007*



Do not mount or dismount the Tractor while the tractor is moving. Mount the Tractor only when the Tractor and all moving parts are completely stopped. (SG-12)



4.1 Boarding the Tractor

Use both hands and equipped handrails and steps for support when boarding the tractor. Never use control levers for support when mounting the tractor. Seat yourself in the operator's seat and secure the seat belt around you.

Never allow passengers to ride on the tractor or attached equipment. Riders can easily fall off and be seriously injured or killed from falling off and being ran over. It is the operator's responsibility to forbid all extra riders at all times. *OPS-U- 0008*



Never allow children or other persons to ride on the Tractor or Implement. Falling off can result in serious injury or death. (SG-10)



Never allow children to operate or ride on the Power Unit or Implement. (SPU-17)



4.2 Dismounting the Tractor

Before dismounting, park the tractor and implement on a reasonably level surface, apply the parking brake, idle the engine down, disengage the PTO, and lower the implement to the ground. Shut down the tractor engine according to the operator's manual, remove the key, and wait for all motion to completely stop. Never leave the seat until the tractor, its engine and all moving parts have come to a complete stop.

Use hand rails and steps when exiting the tractor. Be careful of your step and use extra caution when mud, ice, snow or other matter has accumulated on the steps or hand rails. Use all handrails and steps for support and never rush or jump off the tractor. *OPS-U- 0009*

OPERATION



BEFORE leaving the tractor seat, always engage the brake and/or set the tractor transmission in parking gear, disengage the PTO, stop the engine, remove the key, and wait for all moving parts to stop. Place the tractor shift lever into a low range or parking gear to prevent the tractor from rolling. Never dismount a Tractor that is moving or while the engine is running. Operate the Tractor controls from the tractor seat only. (SG-9)

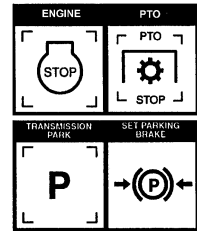

5. STARTING THE TRACTOR

The operator must have a complete understanding of the placement, function, and operational use of all tractor controls before starting the tractor. Review the tractor operator's manual and consult an authorized dealer for tractor operation instructions if needed.

Essential Tractor Controls:

- Locate the light control lever.
- Locate the engine shut off control.
- Locate the brake pedals and the clutch.
- Locate the PTO control.
- Locate the 3-point hitch control lever.
- Locate the hydraulic remote control levers.

Before starting the tractor ensure the following:

- Conduct all pre-start operation inspection and service according to the tractor operator's manual.
- Make sure all guards, shields, and other safety devices are securely in place.
- The parking brake is on.
- The PTO control lever is disengaged.
- The 3-point hitch control lever is in the lowered position.
- The hydraulic remote control levers are in the neutral position.
- The tractor transmission levers are in park or neutral.

Refer to the tractor owner's manual for tractor starting procedures. Only start the tractor while seated and belted in the tractor operator's seat. Never bypass the ignition switch by short circuiting the starter solenoid.

After the tractor engine is running, avoid accidental contact with the tractor transmission to prevent sudden and unexpected tractor movement. OPS-U-0028



Never run the Tractor engine in a closed building or without adequate ventilation. The exhaust fumes can be hazardous to your health. (SG-23)



Start tractor only when properly seated in the Tractor seat. Starting a tractor in gear can result in injury or death. Read the Tractor operators manual for proper starting instructions. (SG-13)



OPERATION

6. CONNECTING THE MOWER TO THE TRACTOR

Use extreme caution when connecting the mower to the tractor. The mower should be securely resting at ground level or setting on blocks. Keep hands and feet from under the mower deck and clear of pinch points between the tractor hitch arms and mower pins. OPS-R-0001



Always shut the Tractor completely down, place the transmission in park, and set the parking brake before you or anyone else attempts to connect or disconnect the Implement and Tractor hitches. (S3PT-15)

6.1 Connecting the Mower Tongue to the Tractor

1. Ensure the tractor is equipped with the correct PTO shaft and the drawbar is set at the correct length.
2. Using the parking jack, position the tongue clevis to the height of the tractor drawbar. Adjust the mower tongue to be level and parallel with the tractor drawbar using the control rod connecting the mower tongue to the deck.
3. Board the tractor and start the engine. Back the tractor to the mower aligning the drawbar hitch hole with the mower tongue clevis. Turn off the tractor engine, place the tractor in park, and set the parking brake before dismounting.
4. To attach the mower, place a 1" washer (1) under top lip of welded Clevis. Add enough 1" spacer washers (2) between bottom of drawbar and bottom lip of Clevis and tighten the 1" locknut & bolt securely. **Note: Attaching a Falcon mower to the tractor 3-Point Hitch IS NOT RECOMMENDED UNDER ANY CONDITIONS.**
5. Securely attach the mower safety chain to the tractor drawbar or drawbar support frame.
6. Lower the jack until the tongue is completely supported by the drawbar. Remove jack from the tongue and place on storage bracket of mower.

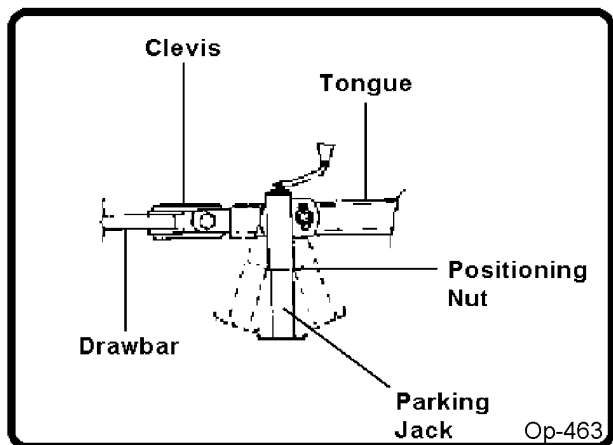

OPERATION

6.2 Safety Tow Chain

If the mower is towed on a public roadway, a safety chain with tensile strength equal to or greater than the gross weight of the mower must be connected between the tractor and mower. This will help control the implement in the event the tongue becomes disconnected from the drawbar. Make sure the chain is attached to a secure location on the tractor and not to an intermediate support.

After connecting both ends of the safety chain, drive the tractor to the right and left to check for proper chain length. Adjust length as necessary and allow only enough slack in the chain to make a maximum turn in both directions. When not in use, store the safety chain to protect it from mud or standing water by wrapping the chain around the tongue. Replace the safety chain if one or more links or end fittings are broken, stretched or otherwise damaged or deformed. *OPS-U-0039*

6.3 Connecting Mower Hydraulic Lines to the Tractor

With the tractor shut down and secured in position, relieve hydraulic pressure from the tractor by moving the control levers back and forth several times or placing the levers in the float position.

When connecting the mower hydraulic lines, keep hoses, quick couplers, and swivels free of contamination. Never leave a disconnected hose end open and cap the tractor hydraulic outlet ports when not in use. If the tractor ports or mower hydraulic hose ends become contaminated, wipe clean with a rag before connecting.

Operating Mower Hydraulics with Three Tractor Hydraulic Ports

Connect one hose into each hydraulic port. Connect lines to correspond with position of hydraulic control levers.

Operating Mower Hydraulics with Two Tractor Hydraulic Ports

The lines that operate the wings must be plumbed together and will be controlled using one hydraulic control valve and the center section with the remaining control valve. Ensure that the operator is aware that each wing cannot be controlled independently nor will they raise and lower simultaneously.

Operating the Mower Hydraulics with a 3-Spool Hydraulic Control Valve (Extra Equipment)

Ensure the valve matches the hydraulic operating system of the tractor (open or closed center). Refer to the Assembly Section for additional information on equipping the tractor with a 3-spool control valve.

Mount the valve bank to a tractor fender or other accessible location. Connect valve bank inlet and outlet lines to outlets of the same tractor hydraulic port. Connect the mower hydraulics to the control valve bank with the center section line to the right port. Connect the wing cylinder lines to the control valve positioned to correspond with the left and right wing.

To activate the 3-spool hydraulic control valve, tie the tractor's hydraulic control lever back to keep hydraulic oil continuously fed to the valve bank

OPERATION

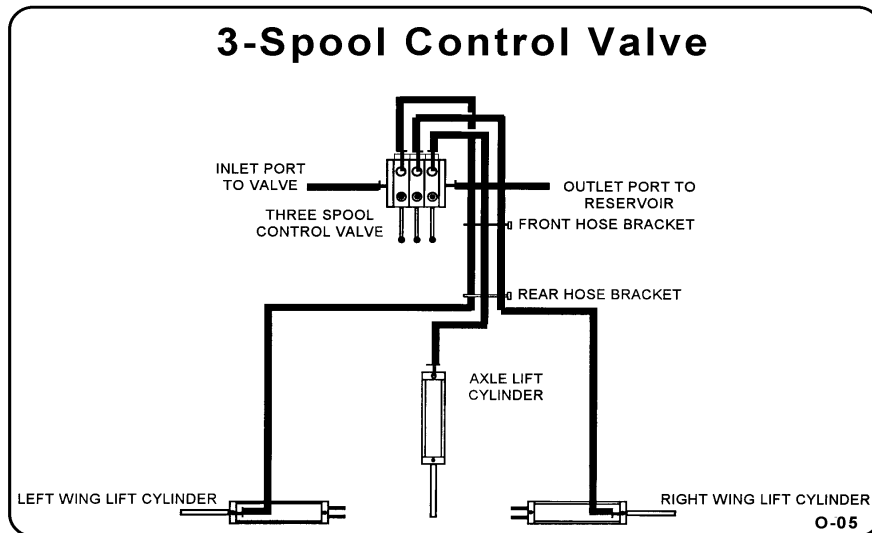

OPERATION

Hydraulic Line Support

After connecting the mower hydraulic lines to the tractor, support the hoses with the equipped brackets. Ensure that hoses do not contact the driveline, do not bind while turning, and do not become pinched or kinked.

Hydraulic Cylinder Priming

Hydraulic Cylinders must be filled with hydraulic oil before removing the wing transport braces to lower the mower wings. Hydraulic cylinders and lines are filled by holding the valve control levers in the raised position until the cylinders fully retract (wing cylinders) and extend (center cylinder). Place control levers in the float position and repeat process a second time. Ensure wings are entirely supported by the cylinders before removing the transport braces. NEVER drive out bar pins and NEVER remove braces that have tension on them.

7. SETTING THE MOWER

Properly setting the cutting height is essential for efficient and safe operation. A properly set mower will make a more uniform cut, distribute clippings more evenly, require minimal tractor work, and follow the contour of uneven terrain. **NOTE:** Avoid very low cutting heights, striking the ground with the blades gives the most damaging shock loads and will cause damage to the mower and drive. Blades contacting the ground may cause objects to be thrown out from under the mower deck. Always avoid operating the mower at a height which causes the blades to contact the ground. OPS-U- 0010



Never work under the Implement, the framework, or any lifted component unless the Implement is securely supported or blocked up to prevent sudden or inadvertent falling which could cause serious injury or even death. (SG-14)



OPERATION

WARNING

Do not let the Blades turn when the Mower Deck is raised for any reason, including clearance or for turning. Raising the Mower deck exposes the Cutting Blades which creates a potentially serious hazard and could cause serious injury or even death from objects thrown from the Blades. (SRM-07)

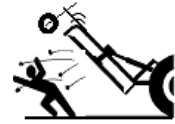

OPERATION

7.1 Leveling Mower

LEVELING DECK CENTER SECTION

1. Place the tractor and mower on a level surface and lower both wings.
2. Using the center section hydraulic cylinder, position the mower so the skid shoes are 1" less off the ground than the desired final cut height. For example, for a 3" cut raise or lower the mower until the skid shoes are approximately 2" off the ground.
3. Shut down the tractor, place the transmission in park, and set the parking brake before dismounting.
4. Level the mower deck front to rear by adjusting the leveling rods linking the tongue to the rear axle. DO NOT allow feet or other body part underneath the mower when making adjustments. To adjust rod length, loosen jam nut and screw turnbuckles. To lower the front, lengthen the rods and to raise the front, shorten the rods. DO NOT unscrew turnbuckles to the point that either rod threaded ends becomes disconnected which will cause the mower to fall. Retighten jam nuts when deck is leveled.
5. **IMPORTANT:** Alternate adjustments between rods and adjust at equal lengths to maintain equal tension. Improper adjustments may cause rods to snap or bend.
6. Place split collar assemblies on the center axle hydraulic cylinder rod to maintain a set cutting height each time the mower is raised and lowered.



LEVELING WING SECTIONS WITH CENTER

1. To level the wing sections with the deck center, adjust the leveling screw between the wing axle and the center axle. To lower the wing, loosen the jam nut and shorten the screw assembly, lengthen the screw assembly to raise the wing. After wings are leveled, retighten jam nuts to maintain settings.

Note: When disconnecting unit to attach to a different tractor always remember to re-level the mower again.



OPERATION

7.2 Setting Deck Pitch

To facilitate safe and efficient operation, the mower should be operated with the deck approximately 3/4" LOWER IN THE FRONT THAN THE REAR.

Operating the mower at this pitch will allow the mower to cut the grass only once and requires less work from the tractor. In addition, a more even distribution of the clippings from the rear of the mower will be achieved with this deck pitch.

Adjust the leveling rods linking the tongue to the rear axle until the front of the mower is at least 3/4" lower in the front than the rear. To lower the front, lengthen the leveling rods and to raise the front shorten the leveling rods. **IMPORTANT:** Adjust the leveling rods the same amount and maintain equal tension in the rods. Improper adjustment may cause rods to snap or bend. Retighten the jamnuts after the deck pitch has been set. OPS-R-0002

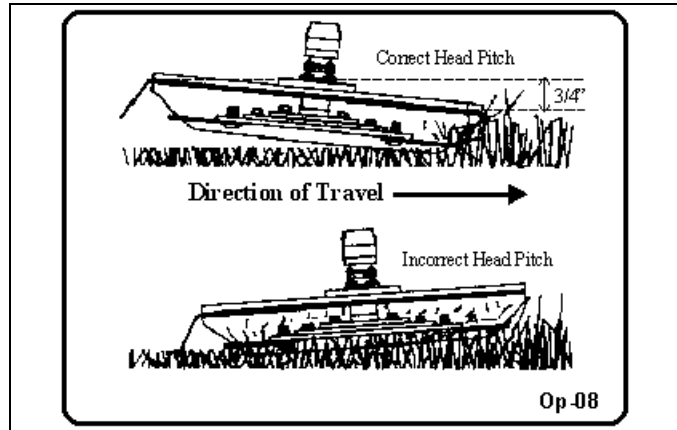

8. PRE-OPERATION INSPECTION AND SERVICE

Before each use, a pre-operation inspection and service of the implement and tractor must be performed. This includes routine maintenance and scheduled lubrication, inspecting that all safety devices are equipped and functional, and performing needed repairs. DO NOT operate the unit if the pre-operation inspection reveals any condition affecting safe operation. Perform repairs and replacement of damaged and missing parts as soon as noticed. By performing a thorough pre-operation inspection and service, valuable down time and repair cost can be avoided. OPS-U-0029

⚠ DANGER

Always disconnect the main PTO Driveline from the Tractor before performing service on the Implement. Never work on the Implement with the tractor PTO driveline connected and running. Rotating Parts, Blades or Drivelines could turn without warning and cause immediate entanglement, injury or death. (S3PT-11)

⚠ DANGER

DO NOT allow any person under a folded wing unless wing is securely locked up or supported. **DO NOT** approach the Implement unless the Tractor is turned off and all motion has ceased. Never work under the frame work, or any lifted component unless the implement is securely supported or blocked up. A sudden or inadvertent fall by any of these components could cause serious injury or even death. (STI-03)



OPERATION

WARNING

Periodically inspect all moving parts for wear and replace when necessary with authorized service parts. Look for loose fasteners, worn or broken parts, and leaky or loose fittings. Make sure all pins have cotter pins and washers. Serious injury may occur from not maintaining this machine in good working order. (SG-21)

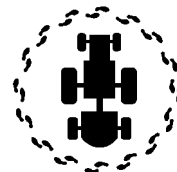

8.1 Tractor Pre-Operation Inspection/Service

Refer to the tractor operator's manual to ensure a complete pre-operation inspection and scheduled service is performed according to the manufacturers recommendations. The following are some of the items that require daily service and inspection:

- Tire condition/air pressure
- Wheel lug bolts
- Steering linkage
- PTO shield
- SMV sign is clean and visible
- Tractor's lights are clean and functional
- Tractor Seat belt is in good condition
- Tractor ROPS is in good condition
- ROPS is in the raised position
- No tractor oil leaks
- Radiator free of debris
- Engine oil level and condition
- Engine coolant level and condition
- Power brake fluid level
- Power steering fluid level
- Fuel condition and level
- Sufficient lubrication at all lube points
- Air filter condition *OPS-U-0030*



OPERATION

Tractor PRE-OPERATION Inspection



Mower ID# _____ Make _____

Date: _____ Shift _____



Before conducting the inspection, make sure the tractor engine is off, all rotation has stopped and the tractor is in park with the parking brake engaged. Make sure the mower is resting on the ground or securely blocked up and all hydraulic pressure has been relieved.

OPERATION

Item	Condition at Start of Shift	Specific Comments if not O.K.
The flashing lights function properly		
The SMV Sign is clean and visible		
The tires are in good condition with proper pressure		
The wheel lug bolts are tight		
The tractor brakes are in good condition		
The steering linkage is in good condition		
There are no visible oil leaks		
The hydraulic controls function properly		
The ROPS or ROBS Cab is in good condition		
The seatbelt is in place and in good condition		
The 3-point hitch is in good condition		
The drawbar pins are securely in place		
The PTO master shield is in place		
The engine oil level is full		
The brake fluid level is full		
The power steering fluid level is full		
The fuel level is adequate		
The engine coolant fluid level is full		
The radiator is free of debris		
The air filter is in good condition		

Operator's Signature: _____

DO NOT OPERATE an UNSAFE TRACTOR or MOWER

This Inspection Form may be freely duplicated for extra copies.

OPERATION

8.2 Mower Pre-Operation Inspection/Service

Before each mower use, a complete inspection and service is required to ensure the mower is in a good and safe working condition. Damaged and/or broken parts should be repaired and/or replaced immediately. To ensure the mower is ready for operation, conduct the following. OPS-R-0007



All Safety Shields, Guards and Safety devices including (but not limited to) - the Deflectors, Steel Guards, Gearbox Shields, PTO integral shields, and Retractable Door Shields should be used and maintained in good working condition. All safety devices should be inspected carefully at least daily for missing or broken components. Missing, broken, or worn items must be replaced at once to reduce the possibility of injury or death from thrown objects, entanglement, or blade contact. (SFL-5)

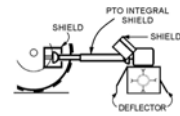

Replace bent or broken blades with new blades. NEVER ATTEMPT TO STRAIGHTEN, WELD, OR WELD HARDFACING ON BLADES SINCE THIS WILL LIKELY CRACK OR OTHERWISE DAMAGE THE BLADE WITH SUBSEQUENT FAILURE AND POSSIBLE SERIOUS INJURY FROM THROWN BLADES. (SGM-10)

The operator's manual and safety signs affixed on the unit contain important instructions on the safe and proper use of the equipment. Maintain these important safety features on the implement in good condition to ensure the information is available to the operator at all times.

- Ensure the manual canister is secured to the equipment with the operator's manual inside.
- Ensure all safety signs are in place and legible. Replace missing, damaged, and illegible decals. OPS-U-0011



KEEP AWAY FROM ROTATING ELEMENTS to prevent entanglement and possible serious injury or death. (SG-24)



OPERATION

- Ensure chain guards and/or rubber deflectors are in position and not damaged. Replace worn, broken, and missing sections immediately.
- Ensure the driveline integral shields are in good condition and rotate freely.
- Inspect that all bolts and screws are in position and are properly torqued. OPS-R-0074



- Perform scheduled lubrication as specified in the maintenance section. OPS-R-0076_A



- Ensure each hydraulic cylinder is installed and retained correctly. Ensure the proper size pins are used to retain the cylinders in place and are secured with pins.
- Check for hydraulic oil leaks on the cylinders, along the hydraulic lines, and at tractor hydraulic ports. **IMPORTANT:** DO NOT use your hands to check for oil leaks. Use a piece of heavy paper or cardboard to check for hydraulic oil leaks. OPS-R-0077



OPERATION

OPERATION

- Ensure that the mower is equipped and secured with wing brace supports.
- Check the condition of the wing hinge pins.
- Check the condition of the mower axle suspension spring.
- Inspect mower tire condition, wheel bearings, and lug nut torque. *OPS-R-0078_A*



- Inspect blades and blade bolts for looseness and excessive wear. Make sure the mower is securely blocked up before crawling beneath. Replace damaged, worn, and missing blades as complete sets to maintain rotary balance.
- Ensure carrier hub nuts are tightened with the cotter pin inserted and spread.
- Inspect the condition of the deck skid shoes and the skid shoe attaching hardware. *OPS-R-0012*



HYDRAULIC PUMP/OIL RESERVOIR

- Check oil reservoir level and oil condition. (Add specific type oil if low)
- Change hydraulic oil filter and hydraulic oil according to maintenance schedule.
- Ensure there are no oil leaks and fitting are properly connected
- Inspect overall condition of hydraulic pump.
- Inspect the tank cooler fan and make sure it is working properly and clear of debris.

OPS-B- 0093



OPERATION

HYDRAULIC LINE INSPECTION

- Check for hydraulic leaks along hoses, cylinders and fittings. **IMPORTANT:** DO NOT use your hands to check for oil leaks. Use a piece of heavy paper or cardboard to check for hydraulic oil leaks.
- Inspect the condition of the valve weldment.
- Ensure fitting is properly connected
- Inspect condition of nylon bushings.
- Inspect Hoses attached between moving points for kinking, pinching, or twisting damage.

OPS-B- 0094

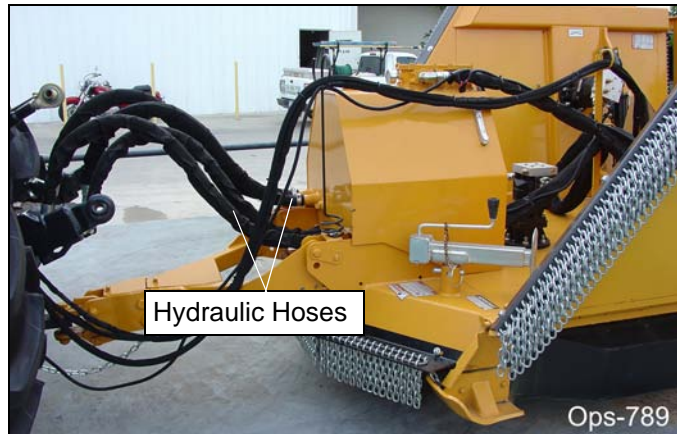

Do not operate this Equipment with hydraulic oil or fuel leaking. Oil and fuel are explosive and their presence could present a hazard. Do not check for leaks with your hand! High-pressure oil streams from breaks in the line could penetrate the skin and cause tissue damage including gangrene. To check for a hose leak, SHUT the unit ENGINE OFF and remove all hydraulic pressure. Wear oil impenetrable gloves, safety glasses and use Cardboard to check for evidence of oil leaks. If you suspect a leak, REMOVE the HOSE and have it tested at a Dealer. If oil does penetrate the skin, have the injury treated immediately by a physician knowledgeable and skilled in this procedure. (SG-15)



SPEED INCREASER AND HYDRAULIC PUMP INSPECTION

- Check for hydraulic leaks along hose connections and fittings. **IMPORTANT:** DO NOT use your hands to check for oil leaks. Use a piece of heavy paper or cardboard to check for hydraulic oil leaks.
- Ensure hdyraulic pump and speed increaser are properly connected to tractor.
- Inspect all hardware is properly torqued
- Ensure Hydraulic hoses and fittings are properly connected.
- Inspect all hoses for kinking, pinching or twisting damage.

OPS-R- 0095

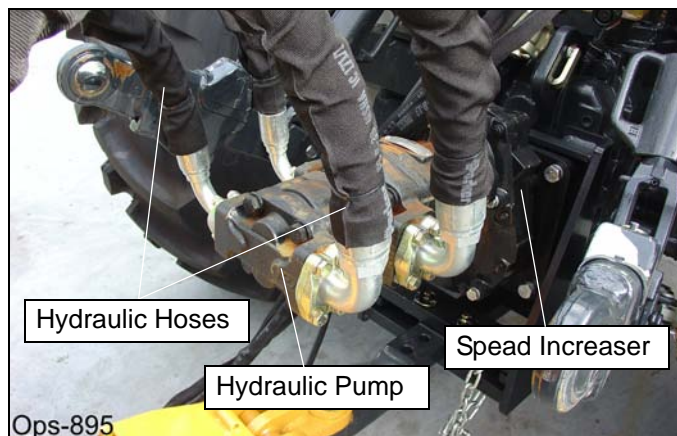

OPERATION

Hydraulic Rotary Mower PRE-OPERATION Inspection



Mower ID# _____ Make _____

Date: _____ Shift _____



Before conducting the inspection, make sure the tractor engine is off, all rotation has stopped and the tractor is in park with the parking brake engaged. Make sure the mower is resting on the ground or securely blocked up and all hydraulic pressure has been relieved.

OPERATION

Item	Condition at Start of Shift	Specific Comments if not O.K.
The Operator's Manual is in the canister on the mower		
All safety decals are in place and legible		
The tongue/hitch connection bolts & pins are tight		
There are no cracks in tongue or hitch		
The tow chain is secured to the tractor & mower		
The hydraulic cylinders pins are tight		
There are no leaking or damaged hoses		
The mower deck is clear of cut grass and debris		
Hydraulic cooler is clear of cut grass and debris		
Chain guards/deflectors are in place & in good condition		
Hydraulic oil is at proper level		
Spindle & Motor mounting bolts are tight		
All grease points are properly lubed		
Blade carrier retaining nut is tight		
Blades are not chipped, cracked or bent		
Blade bolts are tight		
Wheel lug nuts are tight		
Transport locks are in good condition		

Operator's Signature: _____

DO NOT OPERATE an UNSAFE TRACTOR or MOWER

This Inspection Form may be freely duplicated for extra copies.

OPERATION

8.3 Cutting Component Inspection

Inspect blade pan and blade assembly for the following:

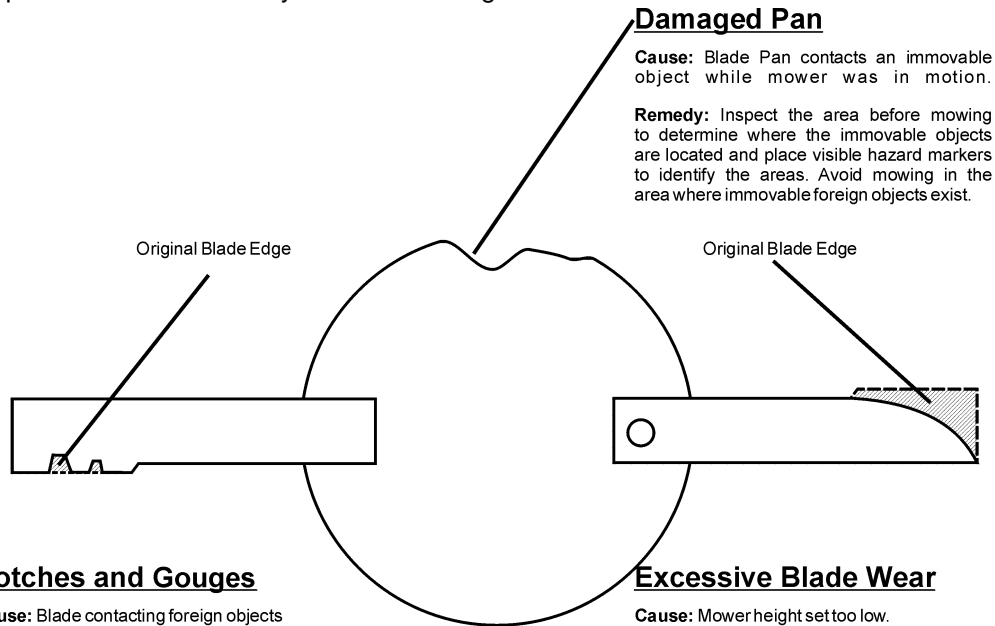

Damaged Pan

Cause: Blade Pan contacts an immovable object while mower was in motion.

Remedy: Inspect the area before mowing to determine where the immovable objects are located and place visible hazard markers to identify the areas. Avoid mowing in the area where immovable foreign objects exist.

Notches and Gouges

Cause: Blade contacting foreign objects

Remedy: Inspect the area to be mowed and remove foreign objects that could cause damage to the blades

Excessive Blade Wear

Cause: Mower height set too low. Blade used past intended life.

Remedy: Replace blades more often. Adjust mower height for mowing Conditions to eliminate blade-to-ground contact

Op-22



Inspect the Blades daily for abnormal wear. REPLACE BOTH BLADES on that carrier IMMEDIATELY if either blade has:

- Become bent or deformed from it's original shape or
- Any cracks are visible, or
- Deep gouges in the blade's surface are present, or
- Gouges or chipped areas in the cutting edge are larger than 1/2"(12.7mm), or
- The material on the leading edge has been worn away by more than 1/2(12.7mm)"

Failure to replace abnormally worn blades may lead to catastrophic failure of the blades and ejection of the broken part with tremendous force which may cause serious bodily injury or death. OPS-U-0032

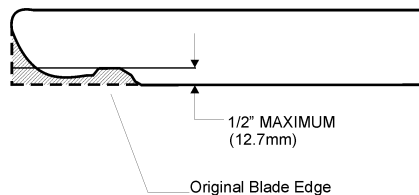

NOTE:
Replace Blades in pairs after no more than 1/2" (12.7mm) wear
Op-23

OPERATION

9. DRIVING THE TRACTOR AND MOWER

Safe tractor transport requires the operator possess a thorough knowledge of the model being operated and precautions to take while driving with an attached implement. Ensure the tractor has the capacity to handle the weight of the mower and the tractor operating controls are set for safe transport. To ensure safety while driving the tractor with an attached mower, review the following:

Read all safety instructions. Decals on the Mower warn you of particular and multiple hazards. Some decals are attached close to part of the Mower where there is a possible hazard. Read and make sure you understand the safety messages before you operate the implement. Keep all decals clean and readable. Replace lost or damaged decals.

Power for operating the mower is supplied from the tractor and idle at a slow engine speed until oil is being pumped. Always engage the PTO at low engine PTO speed and run the mower for a short period until all air is removed from the hoses. Keep all persons well clear of mower since blades can throw objects with great velocity for a considerable distance. **KEEP CLEAR!**

Check the fluid level in the Hydraulic Tank and add oil if required. As the air has been forced out of the hoses, it goes into the hydraulic tank and reduces the volume of oil. Maintain the oil level within the sight gauge located on the side of the reservoir. Never fill the tank above the sight gauge to allow for the expansion of the oil. The tank maintains pressure after the mower has been run. Stand off to one side when removing the breather cap element to prevent possible injury. To relieve pressure remove the breather cap element and depress the spring loaded pressure valve to release any excess air. Fill with Dexron II Automatic Transmission Fluid.



This Implement is wider than the Tractor. Be careful when operating or transporting this equipment to prevent the Implement from running into or striking sign posts, guard rails, concrete abutments or other solid objects. Such an impact could cause the Implement and Tractor to pivot violently resulting in loss of steering control, serious injury, or even death. Never allow the Implement to contact obstacles. (S3PT-12)

OPERATION

WARNING

Transport only at speeds where you can maintain control of the equipment. Serious accidents and injuries can result from operating this equipment at high speeds. Understand the Tractor and Implement and how it handles before transporting on streets and highways. Make sure the Tractor steering and brakes are in good condition and operate properly.



Before transporting the Tractor and Implement, determine the proper transport speeds for you and the equipment. Make sure you abide by the following rules:

Test the tractor at a slow speed and increase the speed slowly. Apply the Brakes smoothly to determine the stopping characteristics of the Tractor and Implement. As you increase the speed of the Tractor the stopping distance increases. Determine the maximum transport speed not to exceed 20 mph (30 kph) for transporting this equipment.

Test the equipment at a slow speed in turns. Increase the speed through the turn only after you determine that the equipment can be operated at a higher speed. Use extreme care and reduce your speed when turning sharply to prevent the tractor and implement from turning over. Determine the maximum turning speed for you and this equipment before operating on roads or uneven ground.



Only transport the Tractor and Implement at the speeds which allow you to properly control the equipment.

Be aware of the operating conditions. Do not operate the Tractor with weak or faulty brakes or worn tires. When operating down a hill or on wet or rain slick roads, the braking distance increases: use extreme care and reduce your speed. When operating in traffic always use the Tractor's flashing warning lights and reduce your speed. Be aware of traffic around you and watch out for the other guy. (SG-19)

9.1 Starting the Tractor

The procedure to start the tractor is model specific. Refer to the tractor operator's manual for starting procedures for your particular tractor. Consult an authorized dealer if the starting procedure is unclear. Ensure the 3-point control lever is in the lowered position and the PTO is disengaged before starting the tractor. OPS-U-0033



OPERATION

9.2 Brake and Differential Lock Setting

Make sure the tractor brakes are in good operating condition. Tractor brakes can be set to operate independently allowing single rear wheel braking action or locked together to provide simultaneous rear wheel braking. **FOR MOST DRIVING AND OPERATING CONDITIONS, THE BRAKE PEDALS SHOULD BE LOCKED TOGETHER TO PROVIDE THE MOST EFFECTIVE BRAKING ACTION.**

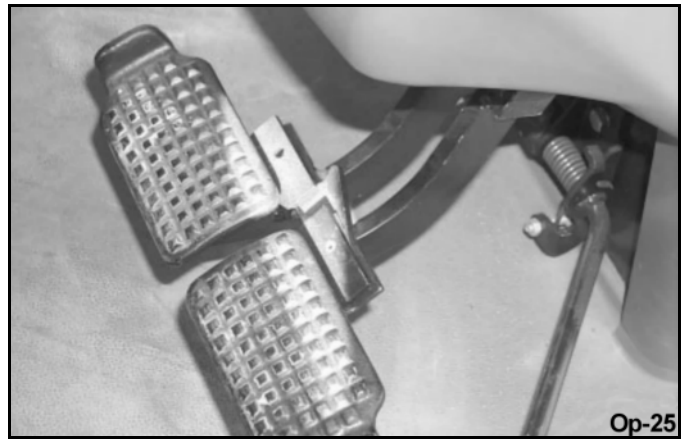

Always disengage the tractor differential lock when turning. When engaged the differential lock will prevent or limit the tractor from turning. During normal cutting conditions, locking the differential provides no benefit and should not be used. *OPS-U- 0013*

⚠ WARNING

Be aware of the operating conditions. Do not operate the Tractor with weak or faulty brakes. When operating down a hill or on wet or rain slick roads, the braking distance increases; use extreme care and reduce your speed in these conditions. When operating in traffic, always use the Tractor's flashing warning lights and reduce your speed. Be aware of traffic around you and watch out for the other guy.

9.3 Operating the Mower Wings

Wings are positioned with hydraulic cylinders. It is recommended that the tractor be equipped with three hydraulic ports or a 3-spool control valve be used so that each section can be controlled independently. Ensure the hydraulic cylinders and lines are filled with oil by holding the valve control levers in the raised position until the cylinders fully retract (wings) and extend (center). As much as possible, operate the mower with both wings fully lowered, the mower can be operated with one or both wings in the raised position, but only operate in this position when the conditions require, such as mowing in narrow areas or raising a wing over an obstacle. Wait until the blades are at a complete stop before proceeding to mow.

⚠ WARNING

Do not let the Blades turn when the Mower Deck is raised for any reason, including clearance or for turning. Raising the Mower deck exposes the Cutting Blades which creates a potentially serious hazard and could cause serious injury or even death from objects thrown from the Blades. *(SRM-07)*



The mower's center of gravity is raised making the mower more prone to tipping when the wings are in the raised position. Use extreme caution when towing the mower in the transport position and avoid uneven terrain which could upset the mower.

⚠ DANGER

When the Wings are folded for transport, the center of gravity is raised and the possibility of overturn is increased. Drive slowly and use extreme caution when turning on hillsides. Overturning the Implement could cause the Implement to overturn the Tractor and vice versa resulting in serious injury or even death. Never fold wings on a hillside...the Implement may overturn. *(STI-02)*

OPERATION

Transport Position

To raise mower wings, drive the unit to a level area and retract the wing hydraulic cylinders. DO NOT raise wings with the mower positioned on an embankment or other inclined position to prevent overturning the mower. After the wings are fully raised, install transport lock braces to prevent wings from inadvertently falling. **NOTE:** *If the transport lock braces can not be easily installed, lower the mower wings and remove rod end of cylinder and adjust the rod clevis in or out to match the transport brace length.*

The center of gravity is raised and the mower more prone to tipping when the wings are in the raised position. When transporting, only raise the center section high enough to clear ground obstacles. OPS-R-0016A



Operating Position

To lower the wings, remove the transport lock braces and secure braces on storage bracket. DO NOT drive out transport brace pins. The wing cylinder may need to be retracted to remove tension for brace removal. After removing brace bars, extend wing hydraulic cylinders and fully lower wings.

The valves operating wing cylinders should be placed in the float position while mowing to allow the mower to follow the contour of uneven terrain and to prevent the wings from creeping up. When extending a wing over a ditch for mowing, place the control valve lever detents in the center position. This will give the mower more stability and prevent the opposite wing from raising. DO NOT operate the mower with the valves in the center position for extended periods of time to prevent deck frame damage. OPS-R-0017_D



Use extreme care when lowering or unfolding the implement's wings. Make sure no bystanders are close by or underneath the wings. Allow ample clearance around the implement when folding or unfolding the wings. Use extreme caution around buildings or overhead power lines. (S3PT-05)

OPERATION

⚠ DANGER

Do not put hands or feet under mower decks. Blade Contact can result in serious injury or even death. Stay away until all motion has stopped and the decks are securely blocked up. (SFL-2)



9.4 Driving the Tractor and Mower

Start off driving at a slow speed and gradually increase your speed while maintaining complete control of the tractor and mower. Moving slowly at first will also prevent the tractor from rearing up and loss of steering control. The tractor should never be operated at speeds that cannot be safely handled or which will prevent the operator from stopping quickly during an emergency. If the power steering or engine ceases operating, stop the tractor immediately as the tractor will be difficult to control.

Drive the tractor with the 3-Point lift arms in the raised position and lock the control lever in the transport detent position to prevent damage to the mower driveline and tongue when turning.

Perform turns with the tractor and mower at slow speeds to determine how the tractor with an attached mower handles a turn. Determine the safe speed to maintain proper control of the tractor when making turns. When turning with a towed implement, the overall working length of the unit is increased. Allow additional clearance for the mower when turning..

To avoid overturns, drive the tractor with care and at safe speeds, especially when operating over rough ground, crossing ditches or slopes, and turning corners. Tractor wheel tread spacing should be increased when working on inclines or rough ground to reduce the possibility of tipping.

Use extreme caution when operating on steep slopes. Keep the tractor in a low gear when going downhill. DO NOT coast or free-wheel downhill. OPS-R-0018A



OPERATION

9.5 Crossing Ditches and Steep Inclines

When crossing ditches with steep banks or going up sharp inclines, it is possible that the hoses between the pump and the mower can be kinked and damaged. This type of abusive operation can cause serious damage to the tractor and mower by causing the hoses to fail or by constricting the oil flow causing excessive heat. **DO NOT OPERATE WITH DAMAGED HOSES!**

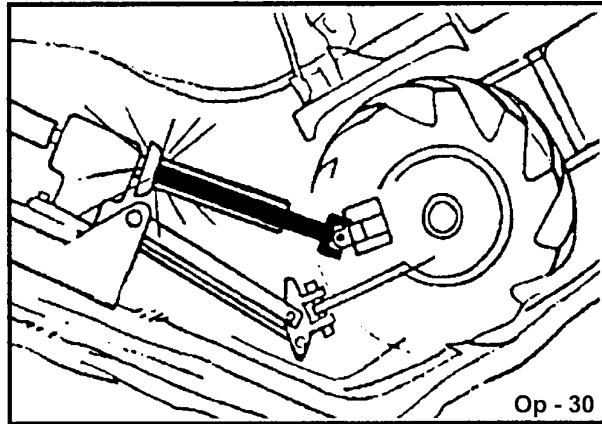

Damage resulting from excessive bending or twisting of the hoses could cause bodily injury to the operator or bystanders and/or extensive damage to the Tractor or Implement.

OPS-R-0020_C

When confronted with an incline or ditch, do not approach from an angle which is perpendicular or straight on as damage to the hoses may occur.

When crossing such terrain, the implement should be fully lowered for a lower center of gravity and added stability. OPS-R-0021_C

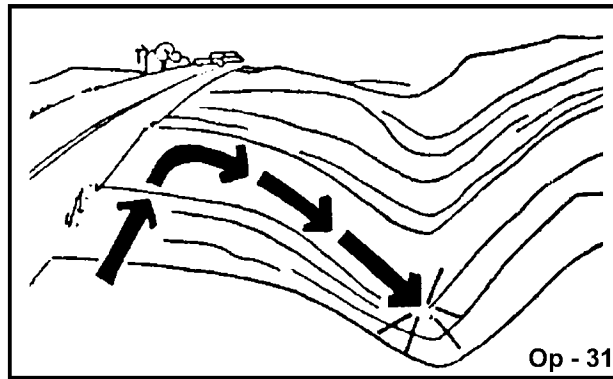

INCORRECT: DO NOT approach ditch straight on

OPERATION

Inclines and ditches should be approached along a line which is at an angle as shown. This type of path will reduce the possibility of over-collapse of the driveline and resulting damage. If the gradient is so steep that such an approach increases the possibility of a tractor roll-over, select an alternate crossing path.

When operating the tractor and mower across slopes and inclines, through ditches, and other uneven terrain conditions, it is important to maintain sufficient deck to ground clearance. Blade contact with the ground may cause soil, rocks and other debris to be thrown out from under the mower resulting in possible injury and/or property damage. Ground contact also produces a severe shock load on the mower drive and to the mower blades resulting in possible damage and premature wear.

OPS-R-0022

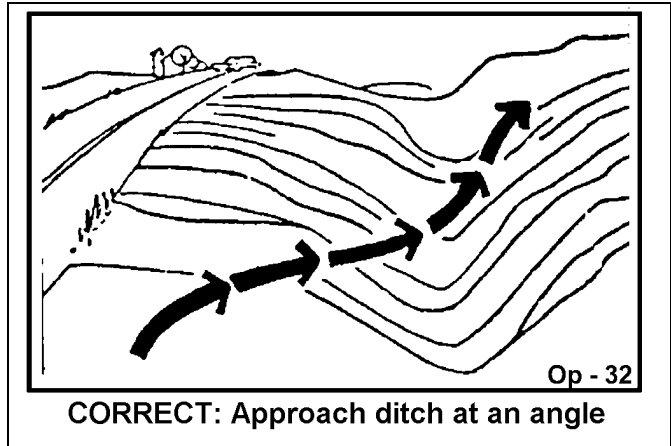

10. OPERATING THE TRACTOR AND IMPLEMENT

THE OPERATOR MUST COMPLETELY UNDERSTAND HOW TO OPERATE THE TRACTOR AND IMPLEMENT AND ALL CONTROLS BEFORE ATTEMPTING TO OPERATE. The operator must read and understand the Safety and Operation Sections of the implement and tractor operator's manuals. These manuals must be read and explained to any operator who cannot read. Never allow someone to operate the implement and tractor without complete operating instructions.

Before starting any operation, the operator must become familiar with the area to be worked in and any obstacles and hazards contained within to ensure safety to the operator, bystanders, and equipment. Special attention should be paid to foreign debris, rough terrain, steep slopes, and passersby and animals in the area.

OPS-U-0015



Extreme care should be taken when operating near loose objects such as gravel, rocks, wire, and other debris. Inspect the area before mowing. Foreign objects should be removed from the site to prevent machine damage and/or bodily injury or even death. Any objects that cannot be removed must be clearly marked and carefully avoided by the operator. Stop mowing immediately if blades strike a foreign object. Repair all damage and make certain rotor or blade carrier is balanced before resuming mowing. (SGM-05)



OPERATION

WARNING

Many varied objects, such as wire, cable, rope, or chains, can become entangled in the operating parts of the mower head. These items could then swing outside the housing at greater velocities than the blades. Such a situation is extremely hazardous and could result in serious injury or even death. Inspect the cutting area for such objects before mowing. Remove any like object from the site. Never allow the cutting blades to contact such items.

(SGM-06)

10.1 Foreign Debris Hazards

Before mowing, inspect the area to make sure there are no foreign objects that the mower blades could hit or become entangled with. Remove all foreign objects and debris. If objects are too big to remove, mark them clearly and be sure to prevent the mower blades from contacting them.

If you hit a solid object or foreign debris, stop the mower and tractor at once. Immediately idle the engine speed and disengage the PTO. Wait for all mower rotating motion to stop, then raise the mower and move the tractor and implement off the object. Inspect the area and remove, or mark the location of the debris. Inspect the condition of the mower and make any needed repairs immediately. Make sure the blades are not damaged and the carrier is balanced before resuming operation.

Always wear your seat belt securely fastened and only operate the tractor and mower with the ROPS in the raised position. If the tractor or mower hits a tree stump, rock, or bump, a sudden movement could throw you off of the seat and under the tractor and/or mower. The seat belt is your best protection from falling off the tractor and the ROPS provides protection from being crushed during a tractor roll-over. OPS-R-0023A



Op-411



Op-478

10.2 Bystanders/Passersby Precautions

If a bystander comes within 300 feet of the tractor while the mower is being operated, stop the tractor at once, idle the engine and disengage the PTO. Do not engage the PTO again until all bystanders are well past the 300 foot distance. OPS-R-0024

OPERATION



Rotary Mowers are capable under adverse conditions of throwing objects for great distances (300 feet or more) and causing serious injury or death. Follow safety messages carefully.



STOP MOWING IF PASSERSBY ARE WITHIN 100 YARDS UNLESS:

- Front and Rear Deflectors, Chain Guards, or Bands are installed and in good, workable condition;
- Mower sections or Wings are running close to and parallel to the ground without exposed Blades;
- Passersby are outside the existing thrown-object zone;
- All areas have been thoroughly inspected and all foreign material such as rocks, cans, glass, and general debris has been removed.

NOTE: Where there are grass and weeds high enough to hide debris that could be struck by the blades, the area should be: inspected and large debris removed, mowed at an intermediate height, inspected, closely with any remaining debris being removed, and mowed again at desired final height. (This will also reduce power required to mow, reduce wear and tear on the Mower drivetrain, spread cut material better, reduce streaking, and make the final cut more uniform). (SRM-01)

10.3 Engaging the Power Take Off (PTO)

Before engaging the PTO, make certain that the area is clear of bystanders and passersby. The implement must be completely lowered and the deck positioned at a safe operating height. NEVER engage the PTO with the implement in the raised position.

Set the tractor engine speed at approximately 1,000 RPM before engaging the PTO. Shift the PTO control to the on position, and slowly increase the engine speed until the PTO is operating at the rated speed. If you hear unusual noises or see or feel abnormal vibrations, disengage the PTO immediately. Inspect the implement to determine the cause of the noise or vibration and repair the abnormality. OPS-U- 0027



Do not let the Blades turn when the Mower Deck is raised for any reason, including clearance or for turning. Raising the Mower deck exposes the Cutting Blades which creates a potentially serious hazard and could cause serious injury or even death from objects thrown from the Blades. (SRM-07)

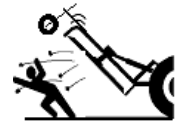

Do not put hands or feet under mower decks. Blade Contact can result in serious injury or even death. Stay away until all motion has stopped and the decks are securely blocked up. (SGM-09)

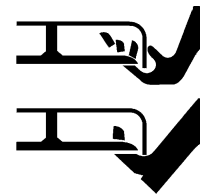

OPERATION

10.4 PTO RPM and Ground Speed

Ground speed for mowing will depend upon the height, type, and density of vegetation to be cut. Recommended speed for efficient mower performance is between 2 and 5 mph(3-8 kph). Operate the mower at its full rated PTO speed to maintain blade speed for a clean cut. Refer to the tractor operator's manual or the tractor instrument panel for the engine speed and gear to provide the required PTO and desired ground speed. Make sure that the mower is operating at its full rated speed before entering the vegetation to be cut. If it becomes necessary to temporarily regulate engine speed, increase or decrease the throttle gradually.

Ground speed is achieved by transmission gear selection and not by the engine operating speed. The operator may be required to experiment with several gear range combinations to determine the best gear and range which provides the most ideal performance from the mower and most efficient tractor operation. As the severity of cutting conditions increase, the ground speed should be decreased by selecting a lower gear to maintain the proper operating PTO speed. *OPS-R-0025*



Do not exceed the rated PTO speed for the Implement. Excessive PTO speeds can cause Implement driveline or blade failures resulting in serious injury or death. (SG-26)



Mow at the speed that you can safely operate and control the tractor and mower. The correct mowing speed depends on terrain condition and grass type, density, and height of cut. Normal ground speed range is from 2 to 5 mph(3-8 kph). Use slow mowing speeds when operating on or near steep slopes, ditches, drop-offs, overhead obstructions, power lines, or when debris and foreign objects are to be avoided. (SGM-07)

Do not over speed the engine to maintain PTO speed when mowing heavy material! Significant engine RPM loss during operation indicates an over loading condition. If this condition occurs, decrease ground speed and/or increase cut height, and/or reduce the cut swath. Mowing in the overloaded condition will quickly overheat the hydraulic oil and could result in component or tractor failure.

10.5 Operating the Mower

Only operate the mower from the tractor operator's seat with the seatbelt securely fastened. The tractor must be equipped with a ROPS in the raised position or a ROPS cab.

The mower is designed to cut vegetation up to 1-1/2" in diameter. Sharp blades will produce a cleaner cut and require less power. Travel at a speed that allows the mower sufficient time to cut through the vegetation and maintain the PTO operating speed to prevent overloading the mower and tractor. Choose a driving pattern that provides the maximum pass length and minimizes turning.

Under certain conditions, tractor tires may roll some grasses down preventing them from being cut at the same height as the surrounding area. When this occurs, reduce the tractor ground speed while maintaining the operating speed of the mower. A slower ground speed will permit grasses to at least partially rebound and be cut. Taking a partial cut and/or reversing the direction of travel may also help produce a cleaner cut.

Avoid mowing in the reverse direction when possible. In situations where the mower must be backed to access areas to be cut, make sure there are no persons or other foreign debris behind the mower before mowing in reverse. When mowing in reverse, operate the tractor and mower at a reduced ground speed to ensure tractor and mower control is maintained. *OPS-R-0026*

OPERATION

WARNING

Do not mow with two machines in the same area except with Cab tractors with the windows closed. (SGM-11)

WARNING

Mow only in conditions where you have clear visibility in daylight or with adequate artificial lighting. Never mow in darkness or foggy conditions where you cannot clearly see at least 100 yards(90 m) in front and to the sides of the tractor and mower. Make sure that you can clearly see and identify passersby, steep slopes, ditches, drop-offs, overhead obstructions, power lines, debris and foreign objects. If you are unable to clearly see these type of items discontinue mowing. (SGM-1)

WARNING

Avoid mowing in reverse direction when possible. Check to make sure there are no persons behind the mower and use extreme care when mowing in reverse. Mow only at a slow ground speed where you can safely operate and control the tractor and mower. Never mow an area that you have not inspected and removed debris or foreign material. (SGM-08)

WARNING

Follow these guidelines to reduce the risk of equipment and grass fires while operating, servicing, and repairing the Mower and Tractor:



- Equip the Tractor with a fire extinguisher in an accesible location.
- Do Not operate the Mower on a Tractor with an underframe exhaust.
- Do Not smoke or have an open flame near the Mower and Tractor.
- Do Not drive into burning debris or freshly burnt areas.
- Ensure slip clutches are properly adjusted to prevent excessive slippage and plate heating.
- Never allow clippings or debris to collect near drivelines, slip clutches, and gearboxes. Periodically shut down the Tractor and Mower and clean clippings and collected debris from the mower deck. (SGM-12)

OPERATION

The unit is designed to greatly reduce the clipping and debris build up on the cooler. However the cooler will periodically need to be inspected and cleaned to remove material, usually once or twice a day depending on mowing conditions. Use a short brush to remove the clippings off the cooler fins on the underside. Brush the clippings out from under the tank where the air enters the cooler. Remove any debris or clippings from the top of the fan as needed. If the cooler becomes excessively clogged, the oil temperature could become too high.

During sharp turns be careful not to allow the tire to come in contact with the tongue or other parts of the mower. When you get to the end of a pass, slightly raise the mower (2-4") before turning. Never raise the mower entirely while the blades are turning. If the mower must be raised higher than 12" from ground level, disengage the tractor PTO and wait for all mower rotation to come to a complete stop before proceeding to raise the mower. NEVER raise the mower wings while the blades are turning. OPS-R-0027F



WARNING

Do not let the Blades turn when the Mower Deck is raised for any reason, including clearance or for turning. Raising the Mower deck exposes the Cutting Blades which creates a potentially serious hazard and could cause serious injury or even death from objects thrown from the Blades. (SRM-07)



OPERATION

OPERATION

Stay alert and watch for trees, low hanging limbs, power lines, and other overhead obstacles and solid ground objects while you are operating. Use care to avoid hitting these items. Set the wing remote levers to the float position to allow the wings to follow the contour of the ground. Set the axle in the center locked position. OPS-R-0028E



When mowing across uneven areas such as road shoulders, ditch edges, and other uneven terrain, position mower so that one support wheel is near the highest point to prevent blades from cutting into gravel or dirt which can cause rapid blade wear and extremely severe shock loads on the drivetrain resulting in rapid wear or damage to these components. Blades contacting the ground may cause objects to be thrown out from under the mower deck. Always avoid operating the mower at a height or position which may cause the blades to contact the ground. Cutting into the berm or edge of the ditch will cause abnormal and accelerated blade wear and possible blade component failure. OPS-R-0029

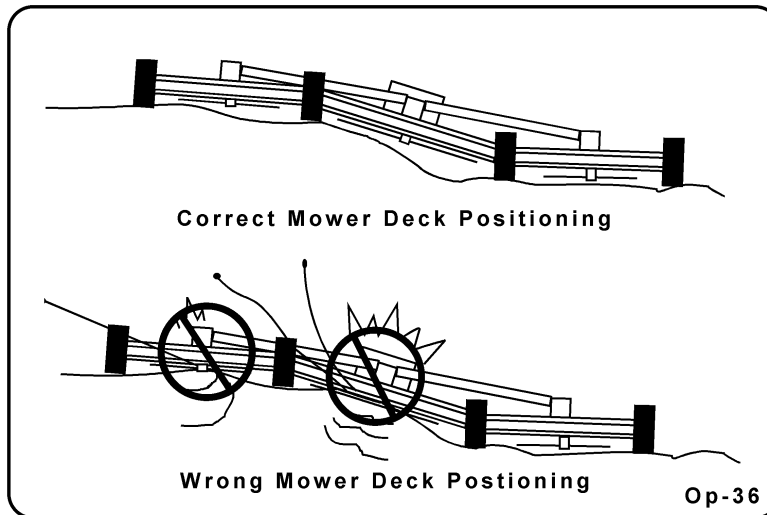

OPERATION

10.6 Shutting Down the Implement

To shut down attached mower head, first bring the tractor to a complete stop. Decrease engine RPM to idle then disengage cutterhead. The mower head will come to a complete stop within a suitable amount of time. Do not engage or disengage the cutterheads at a high RPM unless there is an emergency situation.

Park the tractor on a level surface, place the transmission in park or neutral and apply the parking brake, lower the attached implement to the ground, shut down the engine, remove the key, and wait for all motion to come to a complete stop before exiting the tractor. *OPS-U-0016*



OPERATION

11. DISCONNECTING THE MOWER FROM THE TRACTOR



Always shut the Tractor completely down, place the transmission in park, and set the parking brake before you or anyone else attempts to connect or disconnect the Implement and Tractor hitches. (S3PT-15)



Never unhitch without using the Tongue Jack. The Tongue is very heavy. Attempting to lift the Tongue without using the Tongue Jack could cause strains or other injury. Allowing the tongue to fall suddenly and unexpectedly could result in crushing injury. Use the Tongue Jack for lifting the Implement only. Overloading the Tongue Jack can cause failure with possible serious bodily injury or even death. (STI-04)

OPERATION

OPERATION

When disconnecting the mower, the tractor should be completely shut down and secured in position. Relieve hydraulic pressure by moving the control levers back and forth several times. Lower the parking jack and raise the mower until the tongue clevis is no longer resting on the tractor drawbar and is supported solely by the jack. The jack should be in a near vertical position with the ground and can be adjusted by loosening the positioning nut and moving the jack up to 15 degrees in each direction. Also make sure that the jack foot is securely resting at ground level or securely supported by a block before raising the mower. Once the mower tongue is being supported entirely by the jack, remove the hitch bolt, locknut, and washers. Remove the cylinder hydraulic hoses from the tractor and secure to the mower to prevent contact with dirt.



After disconnecting the mower hitch, remove the pump from the speed increaser. If the pump will remain disconnected from the speed increaser for an extended period of time, apply a thick coat of grease or other substance to prevent the shaft and flange from rusting. If the Tractors PTO is to be utilized remove the speed increaser from the tractor and replace all PTO guarding that came standard with the tractor.

WARNING

After the speed increaser has been removed from the tractor, place the PTO master shield back in the operating position. *OPS-R-0081_B*

Before disconnecting the mower, the PTO must be disengaged and all motion at a complete stop. Move the mower to a level storage location and lower both wings to the ground. If the mower will be stored with the sections in the raised position, be sure that the locks are engaged. If the mower is not resting securely on the ground, block the mower up securely before attempting to disconnect it from the tractor. Use extreme care to keep feet and hands from under the mower and clear of any pinch points.

OPERATION

12. MOWER STORAGE

It is recommended that the mower be stored with the center section and both wings fully lowered to ground level. If the mower is stored with the wings in the raised position, select a level area and install wing transport braces to prevent the wings from falling BEFORE disconnecting the mower hitch from the tractor.

Properly preparing and storing the mower at the end of the season is critical to maintaining its appearance and to help ensure years of dependable service. The following are suggested storage procedures:

- Thoroughly clean all debris off the mower to prevent damage from rotting grass and standing water.
- Lubricate all mower grease points and fill hydraulic oil levels as detailed in the maintenance section.
- Tighten all bolts and pins to the recommended torque.
- Check the mower for worn and damaged parts. Perform repairs and make replacements immediately so that the mower will be ready for use at the start of the next season.
- Store the mower in a clean, dry place with the mower housing resting securely on blocks or at ground level.
- Keep the Pump and Speed Increaser from sitting in water, dirt and other contaminants.
- Use spray touch-up enamel where necessary to prevent rust and maintain the appearance of the mower.

OPS-R-0032_G



OPERATION

Before the start of the next season make sure all debris is completely cleared out of the hydraulic tank cooler fan. Its recommended to use a leaf blower to completely remove all dried grass and debris or compressed air or pressure washer to back-flush the debris from the cooler fins.(when using a pressure washer DO NOT direct the spray into the electric fan motor or toward any electrical connection) Dried grass or any other debris could cause damage to the fan or could start a fire when in operation.



Never allow children to play on or around Tractor or Implement. Children can slip or fall off the Equipment and be injured or killed. Children can cause the Implement to shift or fall crushing themselves or others. (SG-25)

OPERATION

13. TRANSPORTING THE TRACTOR AND IMPLEMENT

Inherent hazards of operating the tractor and implement and the possibility of accidents are not left behind when you finish working in an area. Therefore, the operator must employ good judgement and safe operation practices when transporting the tractor and implement between locations. By using good judgement and following safe transport procedures, the possibility of accidents while moving between locations can be substantially minimized. *OPS-U-0017*



Never allow children or other persons to ride on the Tractor or Implement. Falling off can result in serious injury or death. (SG-10)



OPERATION

Before transporting the tractor and mower, idle the tractor engine, disengage the PTO and wait for all mower moving parts to come to a complete stop. Raise the mower wings and secure in position with transport lock braces. When transporting, only raise the center deck enough to clear ground obstacles to prevent tipping, especially when traveling through rough terrain. *OPS-R-0083*



Before transporting the tractor on a public roadway or boarding a trailer for transport, the tractor brake pedals should be locked together. Locking the pedals ensures that both wheels brake simultaneously while stopping, especially when making an emergency stop.

Use extreme caution and avoid hard applications of the tractor brakes when towing heavy loads at road speeds. Never tow the implement at speeds greater than 20 MPH (25 kph). *OPS-U-0018*

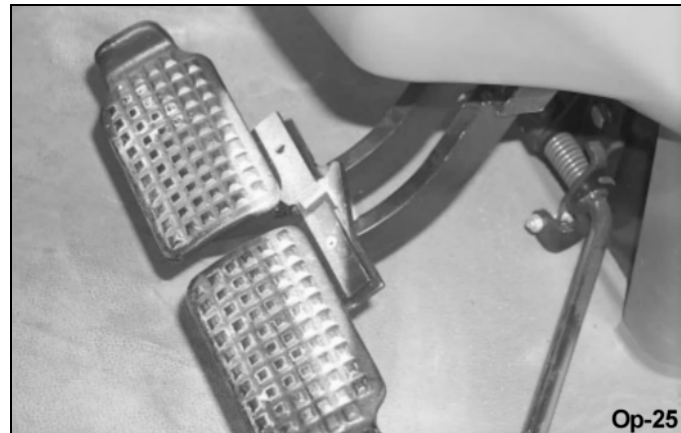

OPERATION

13.1 Transporting on Public Roadways

Extreme caution should be used when transporting the tractor and implement on public roadways. The tractor must be equipped with all required safety warning features including a SMV emblem and flashing warning lights to alert drivers of the tractor's presence. Remember that roadways are primarily designed for automotive drivers and most drivers will not be looking out for you, therefore, you must look out for them. Check your side view mirrors frequently and remember that vehicles will approach quickly because of the tractor's slower speed. Be extremely cautious when the piece of equipment that you are towing is wider than the tractor tire width and/or extends beyond your lane of the road.

Make sure that a proper size safety tow chain is secured between the tractor and implement before entering a public road. OPS-U- 0019

NOTE: Ensure that the mower sections are fully raised and that the transport locks are engaged for each section.



Only tow the Implement behind a properly sized and equipped Tractor which exceeds the weight of the Implement by at least 20%. DO NOT tow the Implement behind a truck or other type of vehicle. Never tow the Implement and another Implement connected in tandem. Never tow the Implement at speeds over 20 MPH. (ST1-06)



Never allow children or other persons to ride on the Tractor or Implement. Falling off can result in serious injury or death. (SG-10)



Make certain that the "Slow Moving Vehicle" (SMV) sign is installed in such a way as to be clearly visible and legible. When transporting the Equipment use the Tractor flashing warning lights and follow all local traffic regulations. (SG-6)

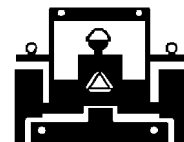

The SMV (Slow-Moving Vehicle) emblem is universal symbol used to alert drivers of the presence of equipment traveling on roadways at a slow speed. SMV signs are a triangular bright orange with reflective red trim for both easy day and night visibility. Make sure the SMV sign is clean and visible from the rear of the unit before transporting the tractor and implement on a public roadway. Replace the SMV emblem if faded, damaged, or no longer reflective. OPS-U- 0020



OPERATION

OPERATION

Make sure that all tractor flashing warning lights, headlights, and brake/tail lights are functioning properly before proceeding onto public roads. While newer model tractors have plenty of lighting to provide warning signals and operating lighting, most older models are only equipped with operating lights. Consult an authorized tractor dealer for lighting kits and modifications available to upgrade the lighting on older tractor models. *OPS-U- 0021*



When operating on public roads, have consideration for other road users. Pull to the side of the road occasionally to allow all following traffic to pass. Do not exceed the legal speed limit set in your country for agricultural tractors. Always stay alert when transporting the tractor and implement on public roads. Use caution and reduce speed if other vehicles or pedestrians are in the area. *OPS-U- 0022*



Reduce speed before turning or applying the brakes. Ensure that both brake pedals are locked together when operating on public roads. *OPS-U- 0023*

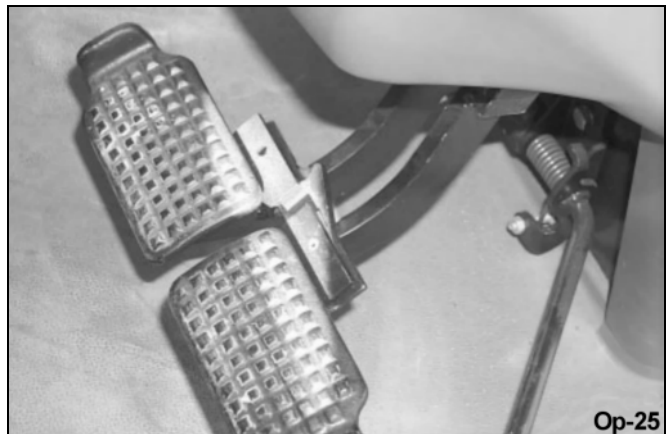

OPERATION

13.2 Hauling the Tractor and Implement

Before transporting a loaded tractor and implement, measure the height and width dimensions and gross weight of the complete loaded unit. Ensure that the load will be in compliance with the legal limits set for the areas that will be traveled through. *OPS-U- 0024*



Use adequately sized and rated trailers and equipment to transport the tractor and implement. Consult an authorized dealer to determine the proper equipment required. Using adequately sized chains, heavy duty straps, cables and/or binders, securely tie down both the front and rear of the tractor utilizing the proper tie down locations as specified by the tractor manufacturer. *OPS-U- 0025*



Arrange the chains so that when tightened, the chains are pulling downward and against themselves. Carefully tighten the securing chains or other fasteners using boomers or binders to apply maximum tension. Use extreme care when attaching and removing the securing devices as the extreme tension involved when released has the potential to inflict serious injury.

While hauling the tractor and implement, make occasional stops to check that the tractor and implement have not moved or shifted and that the securing chains have maintained tension. If during transport a hard braking, sharp turning, or swerving action was performed, stop at the next safe location to inspect the security of the load. *OPS-U- 0026*



OPERATION

14. TROUBLESHOOTING GUIDE

TROUBLE	POSSIBLE CAUSE	POSSIBLE REMEDY
Excessive Vibrations	Spindle & Mower bolts. Check For loose nuts on blade holder and blades Check for bent output shaft. If shaft is bent oil will normally leak from the bottom seal. Check to see if blades are free swinging. Check for even wear on each blade tip. Were both blades changed at the same time? Blade Broken. Blade carrier bent. Blade hub not properly seated on shaft New Blade or bolts matched	Tighten if loose. Tighten If loose Replace shaft if bent. Free blades so they swing Weigh blades. Weight should be within 1 oz. Always replace both blades Replace blades, in sets. Replace carrier. Remove hub, check tapered spline shaft, clean and replace. Replace blades or bolts in sets.
Spindle Overheating	Low on lubricant. Improper type lubricant. Excessive trash build-up around spindle Bearings set up improperly	Fill to level plug. Replace with EP-Z lithium grease. Remove trash. Consult your dealer.
Spindle Noisy	Worn or damaged bearings.	Replace bearings.

OPERATION

TROUBLE	POSSIBLE CAUSE	POSSIBLE REMEDY
Spindle Leaking	Damaged oil seal Bent shaft. Shaft rough in oil seal area. Oil seal installed wrong. Oil seal not sealing in the housing. Hole in housing. Gasket damaged. Bolts loose. Motor Seal Leaking	Replace seal. Replace oil seal and shaft. Replace or repair shaft. Replace seal. Replace seal or use a sealant on OD of Seal. Replace housing or Asy. Replace gasket. Tighten bolts. Replace Motor Seal
Knives Wear Too Fast	Cutting in sandy conditions. Cutting in rocky conditions. Soft "will fit" blades.	Increase cutting height. Increase cutting height. Use genuine Alamo Industrial blades.
Hydraulic Cylinder Oil Leakage	Seal in the cylinder is worn out.	Replace Seal.
Hydraulic Cylinder Will Not	Air in Hoses/Cylinder Not enough pressure. Valve not connected properly Quick coupler not completely connected. Oil level low in Tractor	Continue engaging lever until oil fills hoses & cylinders Pressure test tractor valve Re-plumb valve. Complete connection. Fill to proper level
Tractor Hydraulic Oil Overheating	Incorrect optional valve type installed.(Open center vs. closed center) Tractor lever engaged to contour float position	Reset Relief Valve pressure. Set wing levers to float and axle to center locked position.

OPERATION

OPERATION

TROUBLE	POSSIBLE CAUSE	POSSIBLE REMEDY
Mower Oil Overheating: Oil going over relief valve continuously	Mower not level or pitched correctly Low oil level. Cutting very dense material at high speed or hitting obstructions continually. Relief valve setting has changed to lower pressure due to wear, heat or misuse.	Level and set deck pitch Add Oil the level of sign gauge. Shift to a lower gear in dense material and raise machine over obstructions. Relief valve must be replaced.
Excessive amount of oil leaking past gears.	A worn pump or motor.	Repair the pump or motor See Maintenance Section.
One Wing Section will not cut properly:	Relief valve setting altered. Motor is defective. Pump is defective.	Switch relief valve with wing section; if problem is transferred, replace relief valve. Rebuild or replace motor, Load check the pump and rebuild or replace if defective
Both Wing Section will not cut properly.	Pump is defective. Motor is defective. Suction line to pump has become restricted due to an obstruction or crimp on hose and oil flow to pump is impaired	Check pump and look for metal filings in pump housing and signs of pitting gears. Inspect motors for metal filings in housing, hose, fittings, signs of wear. May need disassembling and repair. Remove obstruction or replace suction lines
Center Section will not cut properly	Faulty relief valve. Suction line to pump has become restricted due to an obstruction or crimp on hose and oil flow to pump is impaired.	Replace relief valve. Remove obstruction or replace suction line.

OPERATION

TROUBLE	POSSIBLE CAUSE	POSSIBLE REMEDY
Discharging Bunches	Blades dull. Grass too wet. Grass too long. Travel speed too fast. PTO speed too low.	Check blades for sharpness. Wait for grass to dry. Mow at 3-1/2" and recut lower. Use a lower tractor gear. Mow at engine RPM to match 540 PTO speed.
Blades Scalping High Places	Mowing too low. Rough, uneven ground. Turning Tractor too fast.	Raise height of cut. Use a slower speed. Slow down when turning.
Uneven Cut	Travel speed too fast. Mower deck not level. Blades dull or unbalanced. Deck underside plugged. Grass too high.	Use a slower speed. Level the mowing deck. Sharpen or balance blades. Clean underside of deck. Mow at higher setting and recut lower.
Grass Clippings Windrow or clump	Grass too wet. Grass too high. Housing plugged.	Wait for grass to dry. Mow at higher setting and recut lower. Clean underside of deck.

MAINTENANCE SECTION

Maintenance Section 5-1

MAINTENANCE

MAINTENANCE

DAILY MAINTENANCE

Daily maintenance is intended for those that need to be lubricated and/or checked daily for proper mower operation. This maintenance should be conducted every morning before the machine is started.

ITEM	DAY				
	M	T	W	T	F
A. HYDRAULIC FLUID					
1. Proper Oil Level					
2. Oil Level Low					
3. Filter Change					
B. BLADES					
C. SPINDLE					
D. NUTS AND BOLTS					
1. Blade Bolts					
2. Blade Carrier Nut & Cotter					
3. Spindle Housing Bolts					
4. Motor Bolts					
5. Speed Changer Bolts					
6. Pump Bolts					
7. Axle Arm Bolts					
8. Winch Stand Bolts					
9. Drawbar Bolts					
10. Wheel Lug Nuts					
E. WHEEL BEARING SEAL INSPECTION					
F. HYDRAULIC HOSES AND CYLINDERS					
G. CLEAN OFF MACHINE					
H. OIL COOLER CLEAN (Every 4 to 8 hours)					

NOTE: Please make copies of this chart and use daily.

MAINTENANCE

Before operating your Rotary Cutter, make sure it is properly lubricated and thoroughly inspected. Only a minimum of time and effort is required to regularly lubricate and maintain this machine to provide long life and trouble free operation.



Always disengage the PTO before raising the Rotary Cutter for transporting or making adjustments.

Lubrication

Do not let excess grease collect on or around parts, particularly when operating in sandy areas. The accompanying illustration shows lubrication points. The chart gives the frequency of lubrication in hours, based on normal operating conditions. Severe or unusual conditions may require more frequent lubrication. **FIGURE MntP-R-0072.**

Use an SAE multi-purpose, lithium-type grease for all locations shown. Be sure to clean the fitting thoroughly before using grease gun.

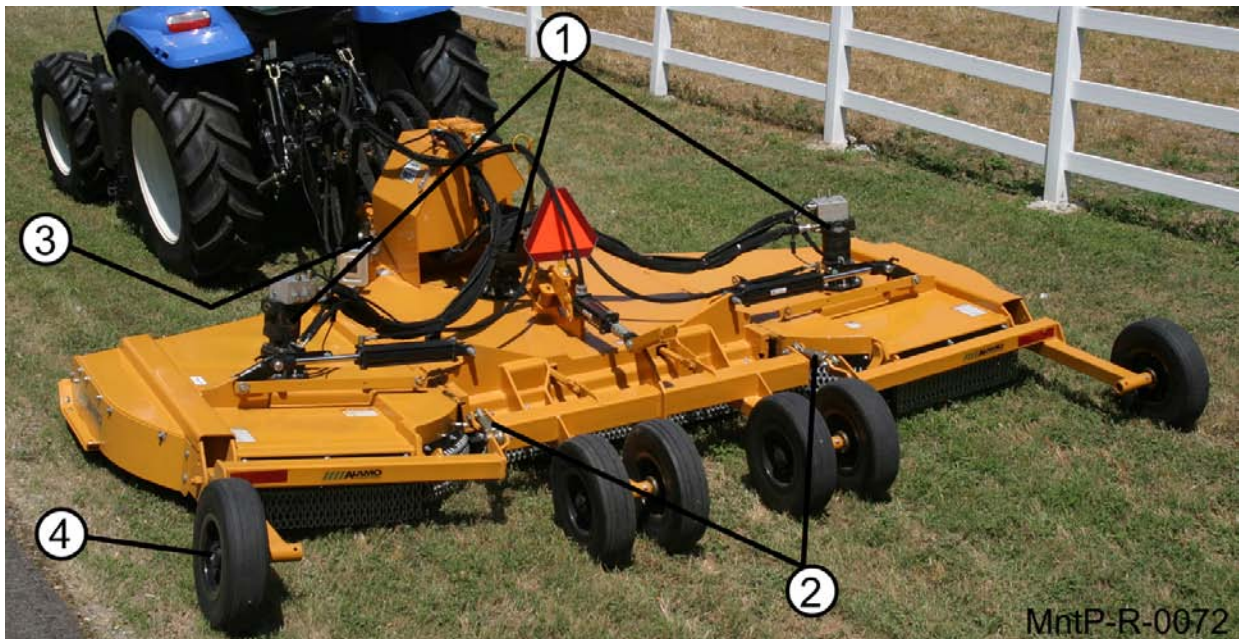

Lubrication Fitting Location

ITEM	DESCRIPTION	FREQUENCY
1	Spindle	Weekly
2.	Axle Turnbuckle	8 Hours
3.	Tongue Pivot	8 Hours
4.	Wheel Hubs	Weekly

MAINTENANCE

MAINTENANCE

WHEEL HUB ASSEMBLY



The Wheel Hub Assemblies need to be lubricated on a weekly basis.

Tongue

The Tongue Hitch Pins attach the Tongue to the Center Section and should be checked for signs of wear or cracking. Replace as needed. The Drawbar 1" Bolt fastens the mower to the tractor Drawbar. When the mower is unhitched and this 1" Bolt is removed, examine for signs of cracking or wear. Replace the Drawbar 1" Bolt at first sign of either problem.

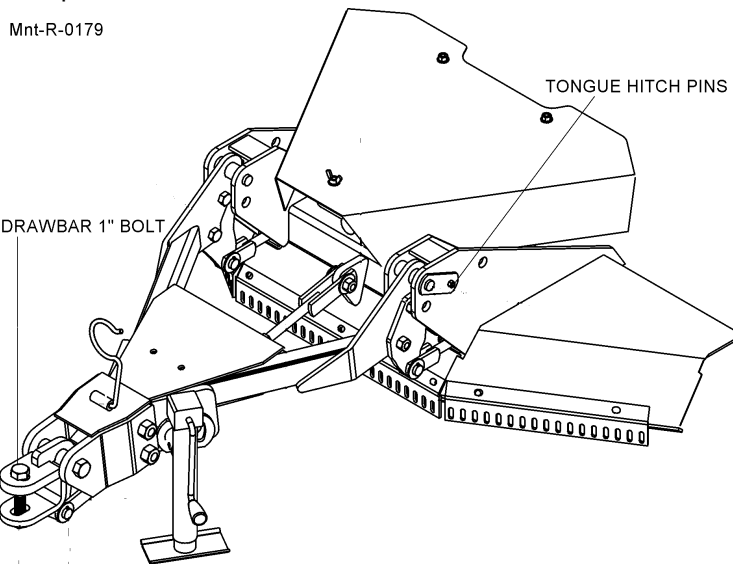

The unit is designed to greatly reduce the clipping and debris build up on the cooler. However the cooler will periodically need to be inspected and cleaned to remove material, usually once or twice a day depending on mowing conditions. Use a short brush to brush the clippings off the cooler fins on the underside. Brush the clippings out from under the tank where the air enters the cooler. Remove any debris or clippings from the top of the fan as needed. If the cooler becomes excessively clogged, the oil temperature could become too high.



MAINTENANCE

Hydraulic Fluid

Maintaining the proper level and cleanliness of the oil is very important for the continued trouble-free operation of the mower and should be checked each morning before the mower is started. Check for any leaks and tighten any fittings which may be loose. The factory hydraulic oil fill is Mobil DTE 16m or an ISO AW68 equivalent. This oil is adequate for most summer mowing conditions throughout the country.

Note: Your ambient temperature and operating conditions may require a different viscosity oil. Please consult the oil manufacturer for proper specifications.

Proper Oil Level

Maintain the oil level within the sight gauge located on the front of the reservoir. When oil is cold, the level should be halfway on the sight gauge. Never fill the tank above the sight gauge level. A space is maintained above this sight gauge to allow for the expansion of the oil. Oil is added through the Filler Breather Cap located in the top of the tank. Thoroughly clean the cap area around the filter to prevent oil contamination. Remove the cap and add oil. Use the oil appropriate for the operating temperature range as shown in decal P/N 02982828. Only add FILTERED oil to the tank using either prefiltered oil or by using a filter cart. Never assume any oil is clean, not even from a new container.



Oil Level Low

Low oil level in the reservoir is caused by leakage of oil. Locate the area of the leak and repair the leak at once. Loss of fluid can cause severe damage to the hydraulic pump and motors.

NOTE: After the first day of operation the mower may require more oil to bring the oil level back into the sight gauge. This is normal. Air trapped in the lines and tanks was displaced by the oil, causing the oil level to go down.

Filter Change - After the first 25 hours of operation, change the oil filters. Replace the oil filters with the new ones provided for you. Thereafter, replace these filters every 500 hours or when the filter condition gauge shows they need to be changed.

MAINTENANCE

Breather Element

The filler cap includes an integrated breather element. The bottom of the cap should be wiped clean each day. If the breather becomes clogged replace the filler cap. Depending on mowing conditions, the filler breather cap may need to be replaced once or twice a season. See **Image Mnt-R-0227**.



BLADES

Blade Servicing

Inspect blades before each use to determine that they are properly installed and in good condition. Replace any blade that is bent, excessively nicked, worn, or has any other damage. Small nicks can be ground out when sharpening.

NOTE: Replace Blades in pairs after no more than 1/2" notch wear!

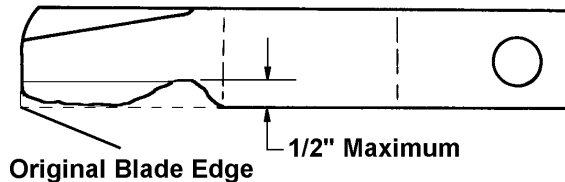

Mnt-R-0034



Use only original equipment blades on this cutter. They are made of special heat-treated alloy steel. **WILL-FIT BLADES MAY NOT MEET SPECIFICATIONS AND MAY FAIL CATASTROPHICALLY AND CAUSE BODILY INJURY OR DEATH.**



Replace bent or broken blades with new blades. **NEVER ATTEMPT TO STRAIGHTEN, WELD, OR WELD HARDFACING ON BLADES SINCE THIS WILL LIKELY CRACK OR OTHERWISE DAMAGE THE BLADE WITH SUBSEQUENT FAILURE AND POSSIBLE SERIOUS INJURY FROM THROWN BLADES.** (SGM-10)



Inspect Blades daily for abnormal wear. If Blades have a notch worn into the leading edge at the lower bend more than a **1/2" DEEP** (due to running in gravel and/or the ground), **REPLACE BOTH BLADES ON THAT CARRIER IMMEDIATELY.** Failure to replace such abnormally worn blades may lead to catastrophic failure of the blade and ejection of the broken part with tremendous force which may cause bodily injury or death!

MAINTENANCE

BLADE SHARPENING

Always sharpen both blades at same time to maintain balance. Follow original sharpening pattern as shown in **FIGURE 19**. Always sharpen blades by grinding. DO NOT heat and pound out edge. Do not sharpen blade to a razor edge, but leave a 1/16" blunt edge. Do not sharpen back side of blade.

IMPORTANT: When sharpening blades, grind each blade the same amount to maintain balance. The difference in blade weights should not exceed 1 ounce. Unbalanced blades will cause excessive vibration which can damage bearings and break welds and other components. Vibration may also cause structural cracks in cutter housing.



Never work under equipment supported by a hydraulic device because it may drop if the control is actuated (even with the engine stopped) or in the event of hose failure, etc. Always use a secure support for equipment which must be serviced while in the raised position.

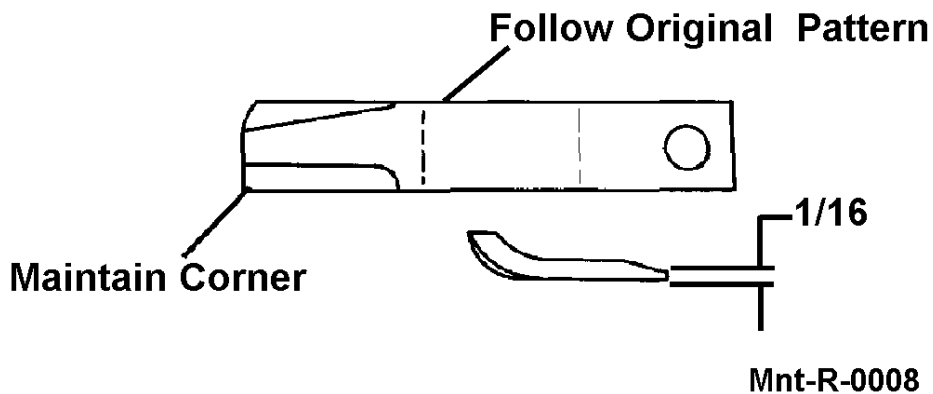

NOTE: Replace Blades in pairs after no more than 1/2" notch wear!

BLADE REMOVAL

To remove blades for sharpening or replacement, remove the cover plate on deck of cutter near gear box. Remove lock nut from blade bolt (left hand threaded bolt). **NOTE:** Inspect lock nut after removal and replace if threads are damaged. Always replace nut when replacing blade bolt. When installing blades be sure and check blade bolt pivot diameter for wear. Replace bolt if worn more than 1/4 inch at any point. See **Figure Mnt-R-0014**. Install blade bolts with partially worn side of bolt either toward or away from center. Tighten lock nut to 300 ft. lbs.

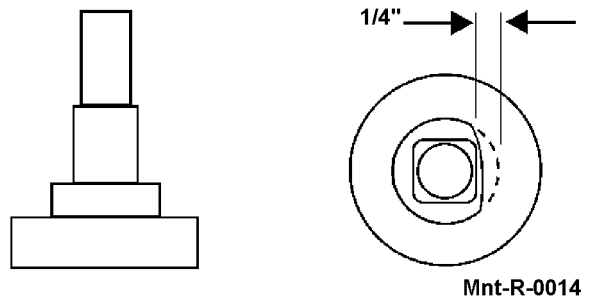

Avoid personal injury. Blade and/or blade carrier removal should be done only with the tractor engine shut off, key removed, in neutral, parking brake on, PTO disengaged, and the cutter blocked in the raised position.

MAINTENANCE

BLADE CARRIER REMOVAL

Remove cotter pin and loosen slotted nut on gear box shaft. Loosen but do not remove the nut until the blade carrier is loosened. Use a suitable two-jaw gear puller to pull carrier off tapered gear box shaft. If gear puller is not available use long bar inserted through blade bolt access hole with end against rotor bar. Strike opposite end of bar with sledge hammer. Rotate blade carrier 180 degrees and repeat process.

BLADE CARRIER INSTALLATION

Clean the splines on both the blade carrier and output shaft. Position carrier on the gear box output shaft and install flat washer and 1" hex nut. Tighten nut holding blade carrier to minimum 450 ft. pounds, strike the carrier on the hub several times with a heavy hammer to seat the hub. Use a suitable spacer over the nut to prevent damage to the nut and threads. Retighten the nut to 450 ft. pounds. Install and spread cotter pin.

NOTE: After a few hours of operation always recheck blade carrier retaining nut torque.



Avoid personal injury. Do not work under cutter without support blocks to keep frame from falling.



Blades should always be replaced in pairs. Blades of different weights can cause serious imbalance and damage to the machine and personnel. When replacing the blades, also replace the blade bolt, nuts and washers. Once the nut has been removed from the blade bolt, it will not fasten tightly on the bolt again. Never weld or modify the blades. The blades are made of a high strength steel and heat treated to give maximum strength and resistance to chipping and wear. Any welding or surfacing applied to the blades can severely reduce its strength. A blade failure could result in a blade segment being thrown at high speeds out from under the machine.

Spindle

Check the spindle to make sure it is properly tight. To do this, grab the blade carrier and pull outward and push inward. See **Image Mnt-R-0229**. There should be no noticeable movement. If the spindle is loose, refer to assembly and disassembly of Spindle Housing on Section 5-17.

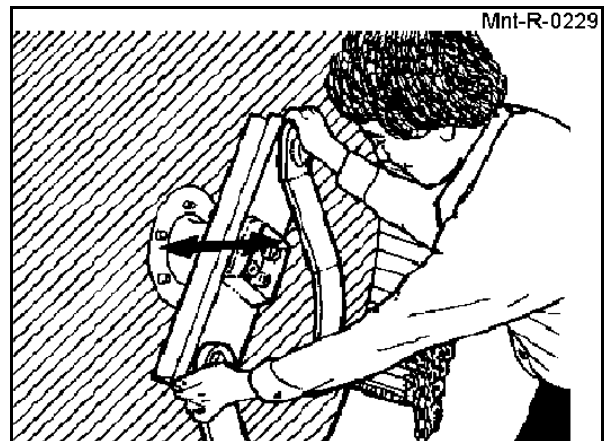

Nuts & Bolts

Most nuts and bolts on the Falcon will stay tight. However, operating over rough terrain can loosen the tightest nut and bolt. If a nut or bolt became loose and failed to perform its function, a part of the machine could fail. Check the following nuts and bolts for proper tightness each morning before start up.

MAINTENANCE

Spindle Housing Bolts -

These bolts fasten the spindle housing to the deck. The bolts should be checked for tightness each morning before the unit is started. They should be torqued to 400 ft./lbs.

Motor Bolts

Examine the bolts that fasten the hydraulic motor onto the spindle housing. Tighten to 85 ft./lbs. of Torque. If these bolts become loose the motor could shift back and forth on the spindle housing breaking the motor flange.

Speed Changer Bolts

The bolts that fasten the mount plate to the tractor and the bolts that fasten the speed changer to the adapter plate are part of this maintenance. These bolts can become loose through vibration and should be checked. If left loose, misalignment of the speed changer and tractor PTO could result which could damage the speed changer. The speed changer bolts should be torqued to 100 ft./lbs. The mount plate bolts should be torqued in accordance with the following bolt sizes: 1/2" - 100 ft./lbs.; 5/8" - 160 ft./lbs.; 7/8" - 400 ft./lbs.

Pump Bolts

The bolts that fasten the pump to the speed changer should be checked, as these could become loose through vibration. They should be torqued to 100 ft./lbs.

Axle Arm Bolts

Inspect the axle arm bolts for proper tightness. The nut should not be loose. DO NOT over tighten these bolts. Tighten the nut on the bolt until it contacts both ears. Then tighten it 1/2 revolution more. The axle arm must be free to move up and down. If one of these bolts slipped out, the suspension system would fail.

Winch Stand Bolts

These bolts fasten the winch stand to the deck. These bolts should be checked each morning before the machine is started. If the winch stand has any play, forward or backward, these bolts need to be tightened. Extreme forces are transmitted thru the winch stand when the wings are raised. If the bolts are loose the winch stand could twist or break.

Drawbar Bolt

Inspect the drawbar bolt for fit. The nut should be pulled up on the bolt such that the clevis is held straight on the drawbar. Use the washers provided to shim any difference between the clevis opening and the drawbar thickness. This will assure proper action of the tongue and clevis. If the tongue clevis sags down, the nut should be tightened.

Blade Carrier Retaining Nut

Check that the cotter pin is present and not damaged. If the nut is missing, retorque as described in Blade Carrier Installation.

MAINTENANCE

MAINTENANCE

Wheel Bearing Seal Inspection

Check each wheel and remove all foreign material that has been wrapped around the spindle. Inspect the grease seal to see that the rubber seal is in complete contact with the metal all around the spindle. If the seal has become worn or cracked, replace it at once.

Hydraulic Cylinders and Hoses

The hoses are made with high strength wire braids and should last several years. If they should become pinched or broken, replace them. Fittings with pipe threads should be assembled with the use of a pipe sealant suitable for hydraulic service. NEVER USE TEFLON TAPE! Other types of fittings are sealed by tightening. Care should be taken so as not to tighten to the point of bursting the fitting. Leaking hydraulic fittings should be attended to immediately because of the loss of oil or as a source of possible inducement of air into the system.

Excessive leakage of oil around the breather plug on a cylinder indicates that the seal in the cylinder is worn out. Replace the seals in the cylinder immediately before premature cylinder damage or loss of high volumes of hydraulic oil occurs.

Cylinder Rod Maintenance

It is important to visually inspect the hydraulic cylinder rods daily before use. It is highly recommended that while the machine is stored or getting very little use that a protectant is applied to the hydraulic cylinder rods to prevent degradation. If the machine receives more frequent use, be sure to fully cycle each cylinder function so that the cylinder rod is coated by the systems hydraulic fluid. Depending on your operating environment it may be necessary, under normal operating conditions, to apply a protective lubricant to the cylinder rods for protection against rust and pitting. Hydraulic fluid may provide a suitable amount of protection, but remember any protectant can attract dust and debris so attention must be given to the cylinder rods daily. Also remember that any other protectant must be compatible with hydraulic fluid. Alamo Industrial is not responsible for rust or pitting of the cylinder rod due to weather exposure or impacts from normal operation or mounting. If hydraulic cylinders and or the cylinder rods are damaged as a result of the rods rusting or pitting, the hydraulic cylinders and rods will not be covered under warranty by Alamo Industrial.

Clean The Machine

The deck should be cleaned off at least once a day. Remove all foreign material from the deck and structural members. Never allow collected grass and dirt to remain in the deck. This material will decompose forming ammonia compounds which will erode the paint and metal deck.

RECOMMENDED HOSE END TORQUE VALUES FOR 37 DEGREE ANGLE STEEL HOSE END FITTINGS

DASH SIZE	NOMINAL SIZE (IN.)	TORQUE (IN.LBS.)	VALUE* (FT.LBS.)
-4	1/4	140	12
-6	3/8	230	19
-8	1/2	450	38
-10	5/8	650	54
-12	3/4	900	75
-16	1	1200	100
-20	1-1/4	1600	133
-24	1-1/2	2000	167
-32	2	2800	233

* Straight threads do not always seal better when higher torques are used. Too much torque causes distortion and may lead to leakage.

Mnt-R-0222

MAINTENANCE

WEEKLY MAINTENANCE

Weekly Maintenance is intended for those items that need to be checked once a week. This maintenance should be performed before start-up the first morning of every new week.

ITEM	O.K.
A. SPINDLE HOUSING	
B. SPEED CHANGER	
C. CHAIN GUARD BOLTS	
D. PINS	
1. Tongue Clevis Pin	
2. Tongue Pins	
3. Hinge Pins	
E. LEVEL LIFT RODS	
G. WHEEL BEARING INSPECTION	
H. CHAIN GUARDS	
I. WINCH AND CABLE	
J. PAINT	

MAINTENANCE

NOTE: Please make a copy of this chart and use weekly.

MAINTENANCE

Spindle Housing

Fill with EP#2 Lithium Based Grease until grease is expelled from grease relief.

IMPORTANT: Make sure spindle housing is equipped with a vented breather plug. If breather plug is clogged or a pipe plug is installed, grease will be forced past the seal. Refer to Spindle Housing disassembly and assembly instructions if necessary (page 5-13)

Speed Changer

Oil in the speed changer should be maintained up to the level plug located about 1/3 of the way up on either side of the speed changer. use an SAE EP 90 wt. oil.

Chain Guard Bolts

These bolts fasten the chain guards to the frame. If a chain guard came off and was mowed over, serious damage could result to the chain guard, blades, or drive train. See **Image Mnt-R-0232**.

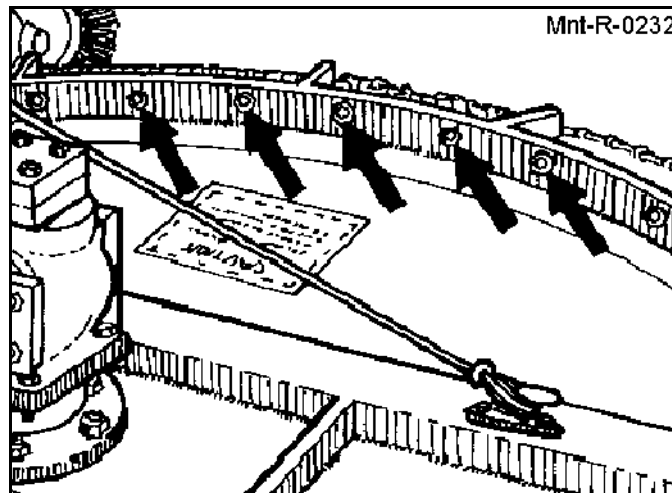

Pins

Many of the pins on the Falcon are made of high strength steel. Always replace pins with genuine Alamo Group parts. Substitute pins may not have the proper strength.

1. **Tongue Clevis Bolt** - This bolt holds the tongue clevis in the tongue, and adjusts the tongue clevis spring tension to hold the tongue clevis in a horizontal position for connecting the tractor to the mower. Inspect this bolt weekly for any signs of bending or abnormal wear. Replace if needed.
2. **Tongue Bolts** - These pins fasten the tongue to the machine frame. Inspect these bolts weekly and make sure they are not excessively worn or loose. If one of these bolts failed, the tongue and suspension system could be seriously damaged.

MAINTENANCE

Hinge Pins -

Check bolt, nut and collar that fastens hinge pin at rear of unit. See **Image Mnt-R-0233**.

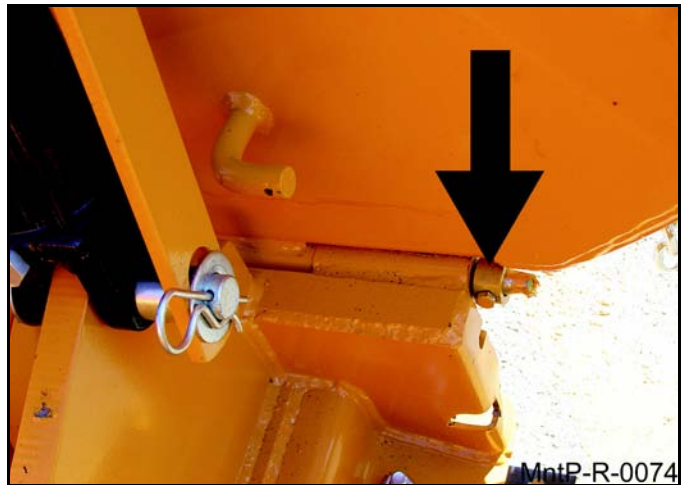

Lift Level Rods

Each level lift rod holds approximately twice the weight of the machine. Careful inspection of each rod and component part is important. Look for excessive wear on the front and rear level lift pins and the drilled holes they ride in. These pins are made of hardened steel and should be replaced only with the proper pins.

Wheel Bearing

The wheel bearings were packed and properly adjusted at the factory. The wheels should be checked each week to see if they need adjustment. Jack the wheel off the ground. Grab the wheel and try to move it in or out. If any movement exists, remove the wheel and inspect the bearings and re-adjust the wheel. If the wheel is operated for only a few hours with it out of adjustment the bearings and hub could be worn to the point that they would need to be replaced. Re-adjustment and repacking of the wheel bearings is covered in the manual Maintenance Section. See **Image Mnt-R-0234**.

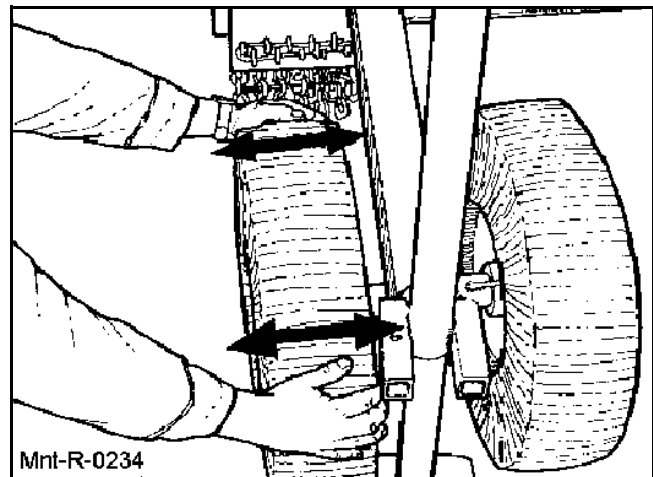

MAINTENANCE

MAINTENANCE

Chain Guards

Inspect the chain guards for any missing chains or cables. Replace any missing chains by undoing the retaining cable clamp. Slide the cable back and insert new 5/16" chain through the slot. Slide the cable back through the chains and re-fasten the cable clamp. Missing chains may allow debris to be thrown out from under the mower. See **Image Mnt-R-0235**.

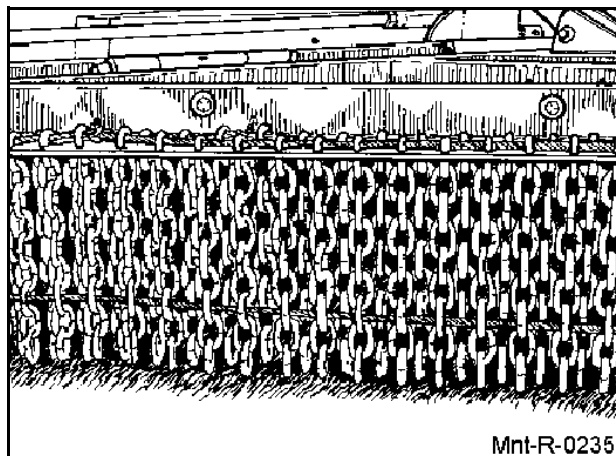

Winch & Cable

(If Equipped)

The winch should be checked weekly. The cable should be replaced at the first sign of fraying or wire breakage. Check to see that the winch functions properly. It should make a "clicking" sound when the cable is being wound up. There should be a resistance when releasing the cable. You should not be able to unwind the winch by pulling on the cable. If the winch does not function properly, replace it. If the winch failed during use, one of the wings could drop suddenly. See **Image Mnt-R-0236**.

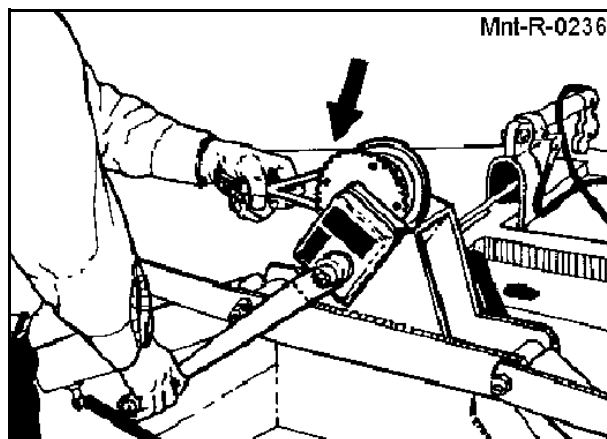

MAINTENANCE

Paint

If there are areas where the paint has peeled or flaked, these should be sanded down to bare metal. New primer and paint should be applied to this area. Decomposing grass can be a very caustic substance. It will eat away the paint and metal and allow rust to set in. Repainting areas will assure longer deck life. See **Image Mnt-R-0237**.

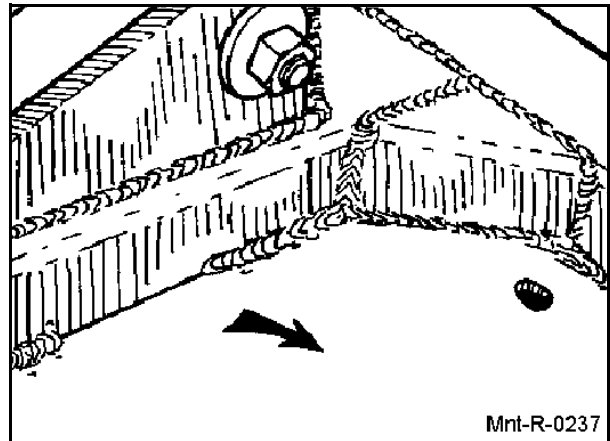

BI-ANNUAL MAINTENANCE

Skid Shoes

The skid shoes are made of a hardened steel to reduce wear and increase their service life. Premature wear can be caused by the mower wings being set too low, allowing the wing shoes to drag on the ground continuously. See **Image Mnt-R-0238**.



Tongue Bolt

Remove the bolt. Examine for signs of abnormal wear and cracks. If any of these parts are worn, bent, or deformed, replace them. These parts hold the tractor and mower together and must be maintained in good working condition. See **Image Mnt-R-0241**.

MAINTENANCE

Drawbar Bolt

This bolt fastens the mower to the tractor drawbar. It should be removed and examined for signs of wear or cracks. This bolt should be replaced at the first sign of wear. See **Image Mnt-R-0241**.



Level Lift System

The level lift rods should be removed from the mower to allow for proper inspection of all components including the shock absorber weldment and the level lift pins. Check each part, especially the level lift pins, for worn areas, mis-shaped holes, or bent components. If any of these signs are found, the parts should be replaced. Reassemble the lift nuts on the mower and check that the level lift system operates properly.

Filter Change

As mentioned under Daily Maintenance, filters should be changed every 500 hours after the initial 25 hour change or whenever the Filter Condition Gauge Shows to change filter. The life of the hydraulic components depends largely on the cleanliness of the oil. Changing filters periodically is a good way of insuring that you can accomplish this.

Oil Change

The oil should be changed every 1500 hours. Drain the oil out of the tank through the large suction hose by removing it from the pump. The suction hoses and pump will need to be primed prior to operation. To do this, reattach the suction hose to the pump and remove it from the tractor. Place the pump assembly below the level of the tank while adding oil to the level of the sight gauge. Loosen the four bolts used to fasten the suction hose to the pump inlet. When oil begins to flow out tighten the bolts. This procedure will prime the pump. Attach the pump and follow the steps stated in the start-up procedure.

MAINTENANCE

Weld Inspection

The deck and structural members of the Falcon are welded using modern up-to-date equipment. Operating over rough terrain can induce severe stress through out the deck and structural members. All welds should be inspected for any signs of cracks or metal separation. If any welds show these signs they should be repaired at once. Any weld that is not repaired can develop into a severe problem that may bend or deform structural members, and cause severe mower damage. See Image Mnt-R-0242.

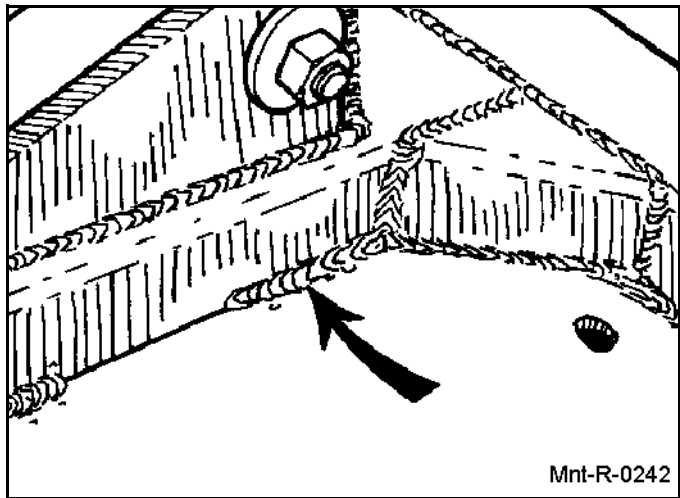

MAINTENANCE

▲WARNING

Be certain to clamp or securely support the Spindle Housing and sub-assemblies to prevent injuries to hands and feet due to inadvertent dropping or falling over.

▲WARNING

Always wear safety glasses and gloves to prevent eye and hand injury when chiselling or hammering on metal components. Hardened metal will chip unexpectedly.

▲WARNING

An assembled spindle housing is quite heavy. Use a hoist or get help to handle them safely. Lift carefully and properly using your legs to lift - NOT YOUR BACK.

ALAMO-INDUSTRIAL LIMITED WARRANTY

1. LIMITED WARRANTIES

- 1.01. Alamo Industrial warrants for one year from the purchase date to the original non-commercial, governmental, or municipal purchaser ("Purchaser") and warrants for six months to the original commercial or industrial purchaser
- 1.02. Manufacturer will replace for the Purchaser any part or parts found, upon examination at one of its factories, to be defective under normal use and service due to defects in material or workmanship.
- 1.03. This limited warranty does not apply to any part of the goods which has been subjected to improper or abnormal use, negligence, alteration, modification, or accident, damaged due to lack of maintenance or use of wrong fuel, oil, or lubricants, or which has served its normal life. This limited warranty does not apply to any part of any internal combustion engine, or expendable items such as blades, shields, guards, or pneumatic tires except as specifically found
- 1.04. Except as provided herein, no employee, agent, Dealer, or other person is authorized to give any warranties of any nature on behalf of Manufacturer.

2. REMEDIES AND PROCEDURES.

- 2.01. This limited warranty is not effective unless the Purchaser returns the Registration and Warranty Form to Manufacturer within 30 days of purchase.
- 2.02. Purchaser claims must be made in writing to the Authorized Dealer ("Dealer") from whom Purchaser purchased the goods or an approved Authorized Dealer ("Dealer") within 30 days after Purchaser learns of the facts on which the claim is based.
- 2.03. Purchaser is responsible for returning the goods in question to the Dealer.
- 2.04. If after examining the goods and/or parts in question, Manufacturer finds them to be defective under normal use and service due to defects in material or workmanship, Manufacturer will:
 - (a) Repair or replace the defective goods or part(s) or
 - (b) Reimburse Purchaser for the cost of the part(s) and reasonable labor charges (as determined by Manufacturer) if Purchaser paid for the repair and/or replacement prior to the final determination of applicability of the warranty by Manufacturer.

The choice of remedy shall belong to Manufacturer.

- 2.05. Purchaser is responsible for any labor charges exceeding a reasonable amount as determined by Manufacturer and for returning the goods to the Dealer, whether or not the claim is approved. Purchaser is responsible for the transportation cost for the goods or part(s) from the Dealer to the designated factory.

3. LIMITATION OF LIABILITY.

- 3.01. MANUFACTURER DISCLAIMS ANY EXPRESS (EXCEPT AS SET FORTH HEREIN) AND IMPLIED WARRANTIES WITH RESPECT TO THE GOODS INCLUDING, BUT NOT LIMITED TO, MERCHANTABILITY AND FITNESS FOR A PARTICULAR PURPOSE.
- 3.02. MANUFACTURER MAKES NO WARRANTY AS TO THE DESIGN, CAPABILITY, CAPACITY, OR SUITABILITY FOR USE OF THE GOODS.
- 3.03. EXCEPT AS PROVIDED HEREIN, MANUFACTURER SHALL HAVE NO LIABILITY OR RESPONSIBILITY TO PURCHASER OR ANY OTHER PERSON OR ENTITY WITH RESPECT TO ANY LIABILITY, LOSS, OR DAMAGE CAUSED OR ALLEGED TO BE CAUSED DIRECTLY OR INDIRECTLY BY THE GOODS INCLUDING, BUT NOT LIMITED TO, ANY INDIRECT, SPECIAL, CONSEQUENTIAL, OR INCIDENTAL DAMAGES RESULTING FROM THE USE OR OPERATION OF THE GOODS OR ANY BREACH OF THIS WARRANTY. NOT WITHSTANDING THE ABOVE LIMITATIONS AND WARRANTIES, MANUFACTURER'S LIABILITY HEREUNDER FOR DAMAGES INCURRED BY PURCHASER OR OTHERS SHALL NOT EXCEED THE PRICE OF THE GOODS.
- 3.04. NO ACTION ARISING OUT OF ANY CLAIMED BREACH OF THIS WARRANTY OR TRANSACTIONS UNDER THIS WARRANTY MAY BE BROUGHT MORE THAN TWO (2) YEARS AFTER THE CAUSE OF ACTION HAS OCCURRED.

4. MISCELLANEOUS.

- 4.01. Proper Venue for any lawsuits arising from or related to this limited warranty shall be only in Guadalupe County, Texas.
- 4.02. Manufacturer may waive compliance with any of the terms of this limited warranty, but no waiver of any terms shall be deemed to be a waiver of any other term.
- 4.03. If any provision of this limited warranty shall violate any applicable law and is held to be unenforceable, then the invalidity of such provision shall not invalidate any other provisions herein.
- 4.04. Applicable law may provide rights and benefits to purchaser in addition to those provided herein.

KEEP FOR YOUR RECORDS

ATTENTION: Purchaser should fill in the blanks below for his reference when buying repair parts and/or for proper machine identification when applying for warranty.

Alamo Industrial Implement Model _____

Serial Number _____

Date Purchased _____

Dealer _____

ATTENTION: _____

READ YOUR OPERATOR'S MANUAL

ALAMO INDUSTRIAL
An Alamo Group Company
Post Office Drawer 549
Seguin, Texas 78156
830-379-1480

8C-002





TO THE OWNER/OPERATOR/DEALER

To keep your implement running efficiently and safely, read your manual thoroughly and follow these directions and the Safety Messages in this Manual. The Table of Contents clearly identifies each section where you can easily find the information you need.

The OCCUPATIONAL SAFETY AND HEALTH ACT (1928.51 Subpart C) makes these minimum safety requirements of tractor operators:

REQUIRED OF THE OWNER:

1. Provide a Roll-Over-Protective Structure that meets the requirements of this Standard; and
2. Provide Seat belts that meet the requirements of this paragraph of this Standard and SAE J4C; and
3. Ensure that each employee uses such Seat belt while the tractor is moving; and
4. Ensure that each employee tightens the Seat belt sufficiently to confine the employee to the protected area provided by the ROPS.

REQUIRED OF THE OPERATOR

1. Securely fasten seat belt if the tractor has a ROPS.
2. Where possible, avoid operating the tractor near ditches, embankments, and holes.
3. Reduce speed when turning, crossing slopes, and on rough, slick, or muddy surfaces.
4. Stay off slopes too steep for safe operation.
5. Watch where you are going - especially at row ends, on roads, and around trees.
6. Do not permit others to ride.
7. Operate the tractor smoothly - no jerky turns, starts, or stops.
8. Hitch only to the drawbar and hitch points recommended by the tractor manufacturer.
9. When the tractor is stopped, set brakes securely and use park lock, if available.

- Keep children away from danger all day, every day...
- Equip tractors with rollover protection (ROPS) and keep all machinery guards in place...
- Please work, drive, play and live each day with care and concern for your safety and that of your family and fellow citizens.



BC-0001